

# **Wiring of electrical distribution boxes in South Korean homes**





## Wiring of electrical distribution boxes in South Korean homes

---



**cs-178-project/imdb.vocab at main · apmalani/cs-178-project**

Contribute to apmalani/cs-178-project development by creating an account on GitHub.

### Explore Power Distribution Box Types and Functions

Power distribution boxes are used in commercial and residential buildings and are part of the electrical system, also known as switchboards.



### South Korea Electric Outlets & Plugs

South Korea, officially known as the Republic of Korea, is a vibrant and modern country located in East Asia. It is famous for its advanced technology, K-pop music, delicious cuisine, and rich cultural heritage.

### How to design an electrical installation? , Legrand Korea South Korea

From electrical circuits to service continuity equipment, including protection devices and solutions for managing consumption or lighting, the design of an installation must be anticipated and prepared.

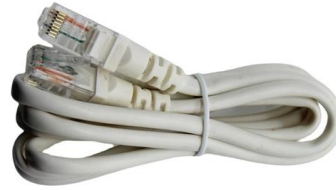

### Expert Q& A on Electrical Outlets and Plugs in South Korea

Using US Panel Boxes in South Korea 220V 60Hz Systems Panel boxes may face compatibility issues with voltage, grounding, and amperage ratings in foreign electrical systems.



### Essential Guide to Electrical Wiring for Homes

Understanding electrical wiring for homes is crucial for ensuring safety, efficiency, and convenience within any residential property. Whether you are



### Expert Q& A on Electrical Outlets and Plugs in South Korea

South Korea's 220V 60Hz single-phase supply uses two 110V hot wires without a neutral or ground. US panel boxes designed for 120/240V split-phase may not match this setup.





## International-electrical-standards-regulations

A new generation of wiring accessories for all your lighting, energy distribution, data and audio-video content, blind management, climate control and safety requirements.



## A Step-by-Step Guide to Wiring an Electrical Panel Box

Find out how to properly wire an electrical panel box with a comprehensive diagram and step-by-step instructions.



## The installation requirements for the distribution box

Learn how to install a distribution box safely and correctly. Covers wiring, placement, standards, and expert tips for a compliant setup.



## The Complete Guide to Electrical Wiring , EEP

The power is subsequently reduced for distribution down the street lines by "step-down" transformers installed at distribution substations. A series of

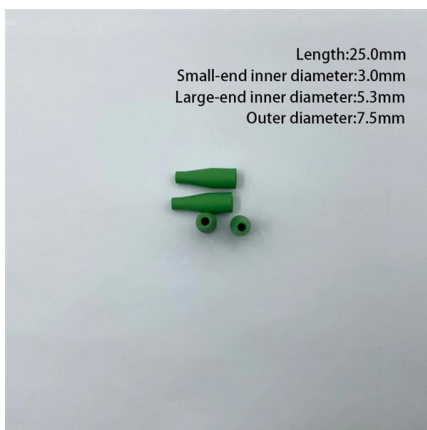



## How to Wire a Home Distribution Box

In this video, we'll walk you through the process of wiring a home distribution box with a detailed connection diagram.

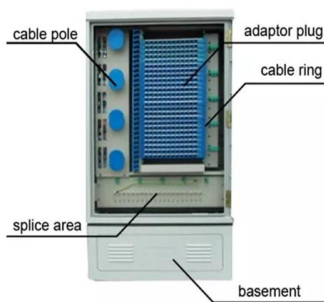

## How to design an electrical installation? , Legrand Korea South Korea

From electrical circuits to service continuity equipment, including protection devices and solutions for managing consumption or lighting, the design of an installation must be anticipated and prepared.

## Electric Panel Installation Method Statement

METHOD STATEMENT FOR Electric panel and distribution box installation and termination - Free download as PDF File (.pdf), Text File (.txt) or read online for



## Home Electrical Wiring Basics: Components, Types, and

Learn the basics of home electrical wiring including wire types, gauges, safety practices, and key components used in residential electrical systems.



## A Step-by-Step Guide to Wiring an Electrical Panel Box

A Step-by-Step Guide to Wiring an Electrical Panel Box An electrical panel box, also known as a breaker box or a distribution board, is a crucial component of any

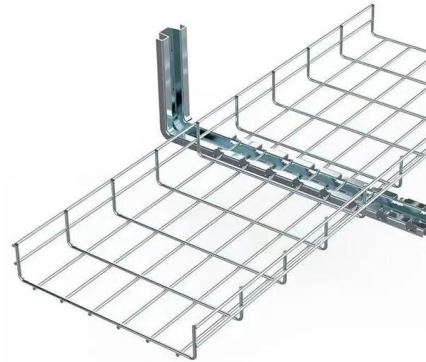

## Understanding Distribution Boxes: A Comprehensive Guide

support safer operation in electrical systems For this reason, distribution boxes are widely used in homes, commercial buildings, industrial

### How to wire a DB - Distribution Board Wiring -

Through the MCB phase lines are distributed to electrical wiring for lighting, fixed devices, and power distribution points. This type of arrangement is

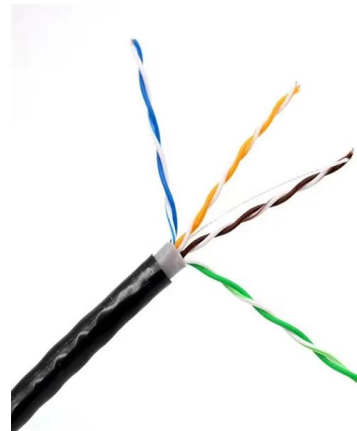

### KIEE

Korean Agency for Technology and Standards, 2017, [KS C IEC 60364-5-52] Selection and erection of electrical equipment - Wiring systems



## The installation requirements for the distribution box

A distribution box is the heart of any electrical system. It takes the incoming power and safely distributes it to different circuits throughout your

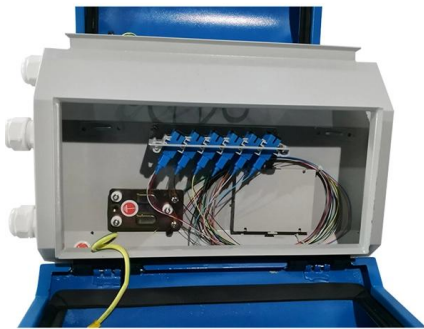

### SANS10142-1\_06-05-12\_wp\_JH\_Amdt 5\_.doc

Foreword This South African standard was approved by National Committee StanSA SC 67F, Electricity distribution systems and components - Installations, in accordance with procedures of Standards

### Distribution Box Wiring Steps

?Wiring Direction?: Wiring between the main circuit breaker and each branch circuit breaker in the box generally goes on the left, and the wiring out of

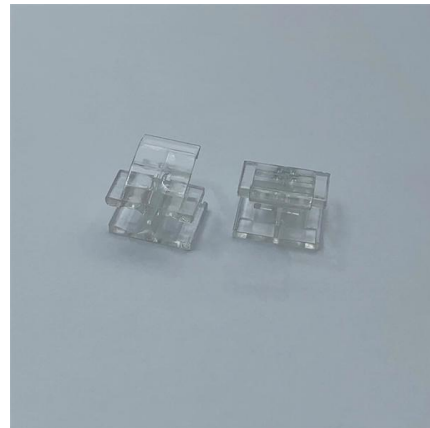

### Structured Wiring for New Construction Homes

Structured wiring is both a physical product and also a process. Often times it is also referred to as a Cable distribution box. In both definitions its typically localized in

### Electrical Distribution Board: Why Proper



## Wiring Matters

Learn about the importance of proper wiring in an electrical distribution board and how it impacts your home's safety and efficiency. Ensure



## How to Choose a House Distribution Box , CHINT global

A well-chosen distribution box ensures the safety and efficiency of your household electrical system. This article guides you through selecting a



## How to Install a Distribution Box in Singapore?

Guide to distribution box installation in Singapore, covering planning, wiring, circuit setup and safety. Ensure proper setup or consult a licensed electrician.



## Which electrical installation carry out in homes?

From the design of the electrical panel to the creation of the electrical circuits, including grounding, an electrical installation requires anticipation and precision in



## Electric > Rent and Utilities > Housing > ibs

South Korean electricity is 220 volts. Plugs are Type C and Type F, as specified by the International Electrotechnical Commission. Plugs consist of two round pins



## From the Ground Up: Electrical Wiring

Read our guide to electrical wiring, covering layout, materials, safety, and planning for a safe, efficient home system.

## Exploring Korea's Electrical Wonders: Mastering the Power Outlet Puzzle

Discover the complete guide to Korea's power outlets: types, voltage, plug adapter requirements, and essential travel tips. Stay connected while exploring South or North Korea with

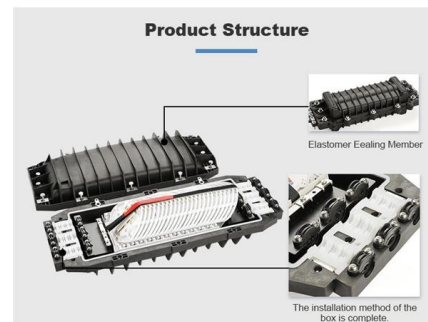

## Contact Us

For datasheets, pricing, or custom high-speed optical interconnect solutions, please visit:  
<https://www.syropy.com.pl>