

# **Which companies manufacture AI servers**

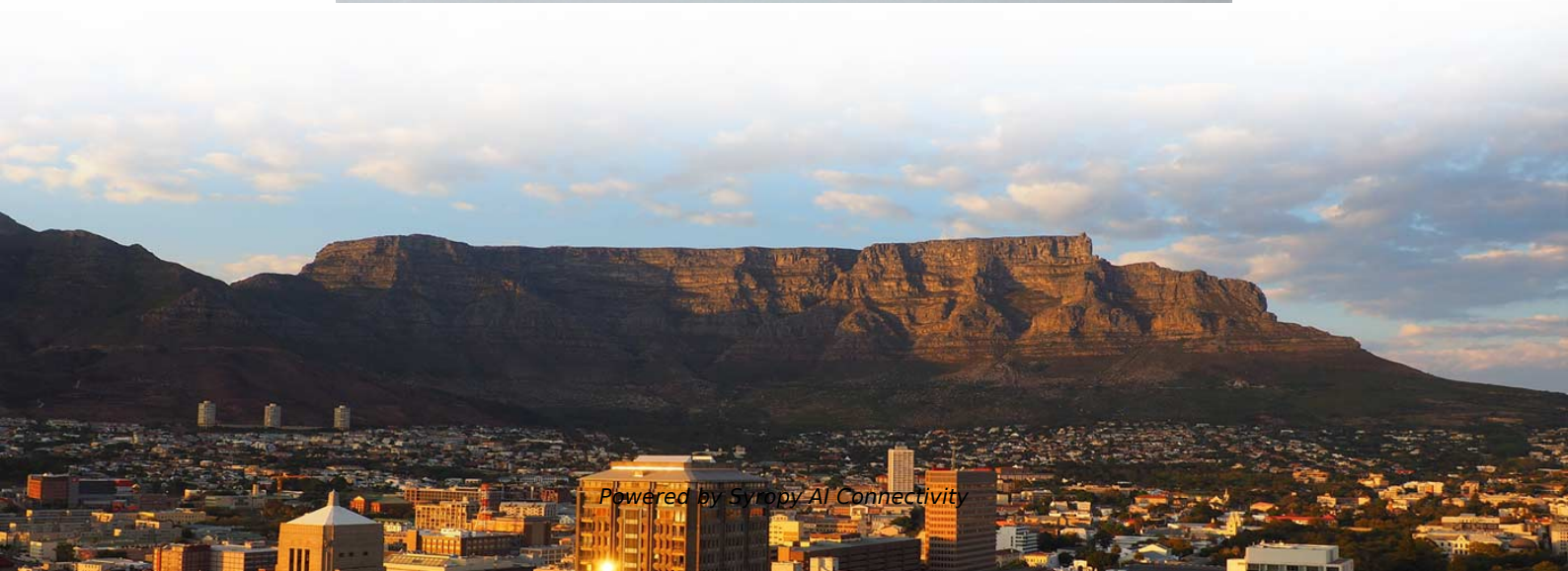

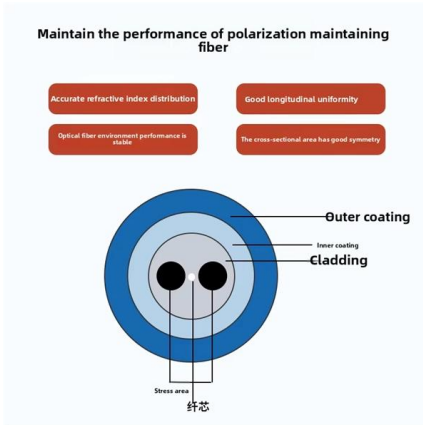

## Which companies manufacture AI servers



### AI Server Companies

AI Server industry insights on factors that are driving the growth of the AI Server Market and key players along with their go to market strategies and new revenue sources.

### Top 10 AI Hardware Providers in 2025

Top AI hardware companies include NVIDIA, AMD, Intel, Apple, Qualcomm, Google, AWS, Microsoft, TSMC, and Graphcore, powering AI



### Top AI Servers Companies for High-Performance Computing in 2025

Discover leading AI servers companies offering cutting-edge solutions for machine learning and deep learning. Find high-performance, scalable systems optimized for AI workloads. Click to explore top

### Dell slides as high AI server costs, competition blunt

Shares of Dell Technologies fell about 10% on Friday, as high manufacturing costs for AI-optimized servers and intensifying competition

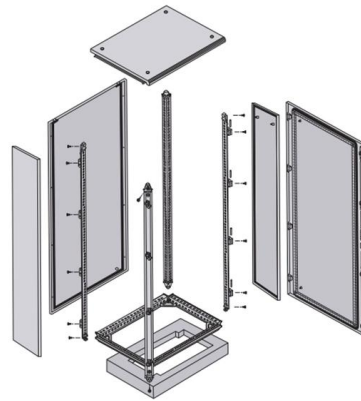

### AI Server Companies Driving AI Innovation in 2025

While semiconductor giants like NVIDIA and AMD develop the hardware that powers AI servers, specialized AI companies like TensorWave, Lambda Labs, and Cerebras Systems are

### Top Five AI Server Companies for Data Centers and

This ABI Research competitive assessment ranks the top five AI server companies worldwide.



### Artificial Intelligence (AI) Servers - Intel

Explore key considerations for AI servers and how to design them to support AI workloads optimally.



### Top Five AI Server Companies for Data



## Centers and

To bring clarity to the market, ABI Research's AI Server OEMs Competitive Ranking assesses eight global AI server companies. We evaluated

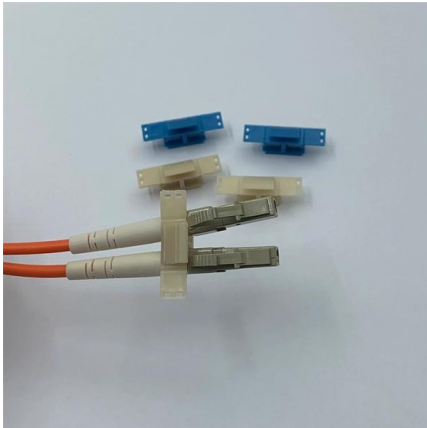

### **Top AI Server Companies & How to Compare Them (2025)**

The AI Server landscape is evolving rapidly, driven by the need for higher processing power, efficiency, and scalability. Enterprises are seeking solutions that can handle complex

### **Best AI Server Manufacturers: Top Suppliers for High-Performance**

As enterprises globally invest billions into AI infrastructure, selecting the right high-performance AI server supplier is paramount. This guide will help you navigate the global landscape,



### **AI Server Companies , Leading Providers & Solutions**

Discover top AI server companies offering high-performance infrastructure for machine learning, AI training, and data processing.



## 10 top AI hardware and chip-making companies in 2026

AI hardware and chip-making companies constantly advance products to keep up with the competition. Here is a look at the 10 top companies in 2026.



## The 25 Hottest AI Companies For Data Center And Edge: The 2025

CRN's list of 25 companies that are paving the way for the AI revolution in data centers and at the edge include tech behemoths

## NVIDIA to Manufacture American-Made AI

NVIDIA is working with its manufacturing partners to design and build factories that, for the first time, will produce NVIDIA AI supercomputers entirely in



## Google may manufacture AI servers in India, says minister

Google's manufacturing plan: Minister Ashwini Vaishnaw said Google has agreed to consider making AI servers in India, following a meeting with senior company officials. Policy



## Top AI Server Companies Powering Modern Intelligence

Discover the leading AI server companies driving innovation, boosting performance, and redefining how businesses handle complex AI workloads.



## AI Server Companies Driving AI Innovation in 2025

Behind every smart AI algorithm is a powerhouse of raw computing: servers that process billions of calculations per second, data centers that

## SoftBank explores homegrown AI servers with Nvidia, Foxconn: Report

SoftBank is exploring plans to manufacture artificial intelligence servers within Japan. The company is in talks with chip giant Nvidia and contract manufacturer Foxconn. Initially, SoftBank

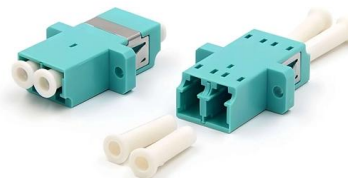

## The AI Servers Powering The Artificial Intelligence Boom

IDC expects AI server revenue will reach \$49.1 billion by 2027, assuming that GPU-accelerated server revenue will grow faster than revenue for



## Top AI Server Companies & How to Compare Them (2025)

With numerous vendors vying for dominance, choosing the right AI server can be daunting. Understanding the key players and evaluation criteria is essential for making informed decisions.

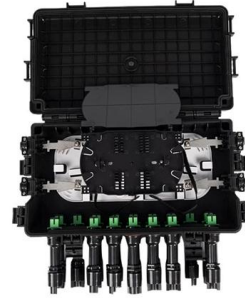

## The 25 Hottest AI Companies For Data Center And Edge: The 2024

Here are the 25 companies leading the AI revolution and innovation race in servers, chips, networking, storage,

### AI Server Companies

Dell Inc. (US), Hewlett Packard Enterprise Development LP (US), Lenovo (Hong Kong), Huawei Technologies Co., Ltd. (China), and IBM (US) are the major players in the AI server market.

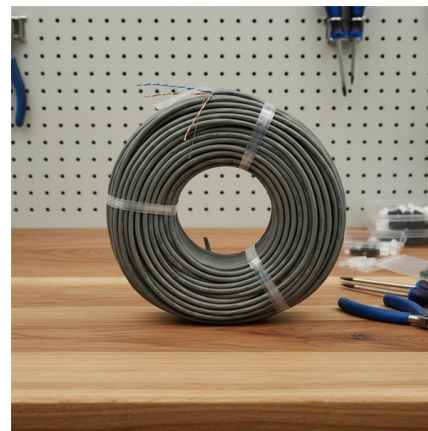

## Contact Us

---

For datasheets, pricing, or custom high-speed optical interconnect solutions, please visit:  
<https://www.syropy.com.pl>