

Ultra-thin distribution box panel cover





Overview

The Ultra-Thin Solid Wood Weak Electromagnetic Box Cover Panel is designed to protect your WiFi multimedia signal distribution box while adding a touch of elegance to your home. At the same time, they avoid the risk of electric shock to maintenance personnel when inspecting components. The cover of a distribution box can be made of various materials, including metal, plastic, or composite materials, and may be designed to protect the box from damage, provide easy access to its contents, or facilitate its installation and maintenance.



Ultra-thin distribution box panel cover

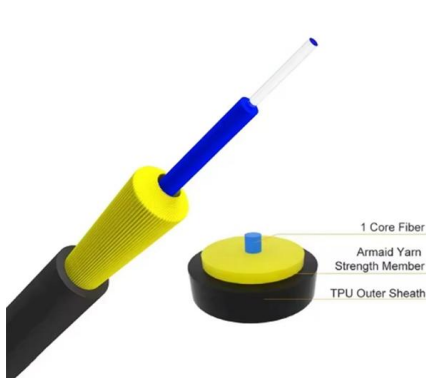

Amazon : Circuit Breaker Box Cover

Breaker Box Cover Decorative 13.7x17.7Inch, Wall Mounted Electrical Panel Cover Distribution Box Decorative Painting for Living Room, Bedroom, Office, Cafe See

Custom Electrical Panel Cover

Electrical panel covers are metal panels used to protect electrical boxes and circuit breaker boxes. They effectively prevent the ingress of water, dust and debris. At



Electric Panel Board Cover

If you're looking for a stylish and functional way to protect your WiFi multimedia signal distribution box, this Ultra-Thin Solid Wood Weak Electromagnetic Box Cover Panel is the perfect choice.



2-Way Distribution Protection Box, IP66 Waterproof

About this item Transparent Cover: This 2-way electric panel DIN distribution box provides safety protection for your wall circuit, the surface is a transparent gray

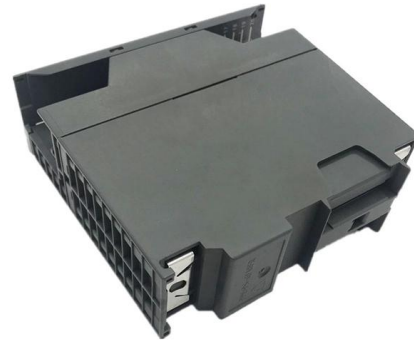

smseace Distribution Protection Box, ABS Plastic Transparent Cover

Product name: Distribution protection box (design of 8 ways circuit breakers) Material: The shell is made of ABS plastic, the cover is made of transparent PC, the sealing ring is made of silicon rubber, and



Waterproof Electrical Distribution Box, SHPN Series

The Waterproof Electrical Distribution Box, with its high-definition transparent cover, is a transparent panel that not only allows for easy monitoring of the internal

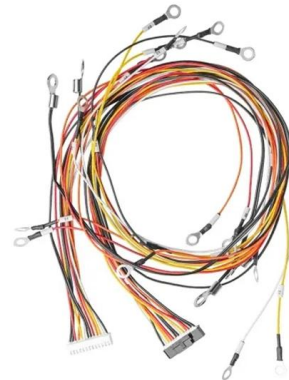

Amazon : Electric Panel Cover

Breaker Box Cover Decorative 19.7x27.6 in, Wall Mounted Electrical Panel Cover Distribution Box Decorative Painting for Living Room, Bedroom, Office, Cafe Save 5% with coupon





Ultra-Thin Meter Box Blocking Decorative Weak Current Box

welcome to taobao purchase ultra-thin electric meter box decoration baffle, taobao tens of billions of hot selling goods, official logistics can be sent to the global ten, support foreign currency payment and



Meter Box Blocking Decorative Weak Current Box Cover Ultra-Thin

welcome to taobao purchase ultra-thin electric meter box decoration baffle, taobao tens of billions of hot selling goods, official logistics can be sent to the global ten, support foreign currency payment and

Transparent protective cover for electrical distribution boxes , 6

Outdoor installations: Used for electrical and control systems in outdoor environments. Electrical distribution panels: Suitable for protecting switches, indicators, and other electrical components.

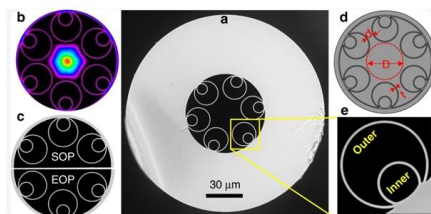

Universal Distribution Boards, covers and accessories

Universal Distribution Boards, covers and accessories. Customer focused design for all applications and environments. Known for ease of installation and service.



Circuit Breaker Distribution Box Electrical, Outdoor

MAKERELE IP65 waterproof distribution protection box, made of ABS plastic, and the use of plastic transparent cover is convenient to check the running status of

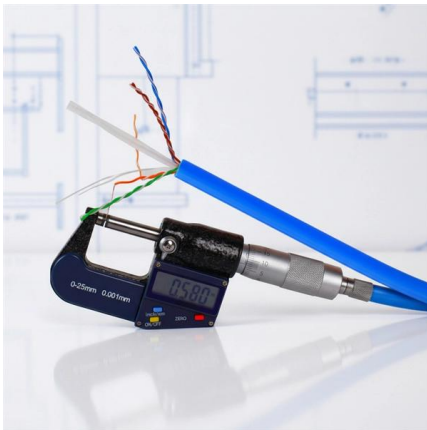

Distribution board cover

Discover IP65-IP67 rated distribution board covers in metal & plastic. Waterproof, dustproof, CE-certified for home & commercial use.

Distribution Box Cover

Looking for distribution box cover? The cover of a distribution box can be made of various materials, including metal, plastic, or composite materials, and may be designed to protect the box from

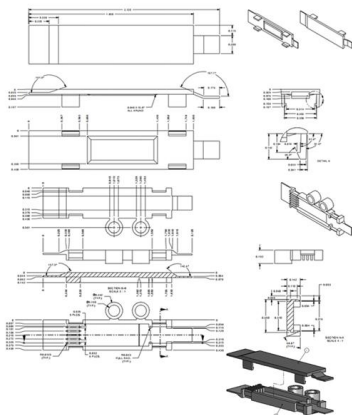

Amazon : Electrical Panel Cover

Protect your electrical panel with sturdy, long-lasting covers. Explore a range of decorative, flush-mount, and surface-mount designs to suit your home's needs.



Ultra-Thin Meter Box Blocking Decorative Weak Current Box

From ?200 Sign in to see personalized deals Ultra-Thin Meter Box Blocking Decorative Weak Current Box Blocking Panel Distribution Box Multimedia Signal Box Cover Network Cable Box Reviews(3) All



Plastic Transparent Cover Power Distribution Protection

Product description Features: Made of high quality plastic material, this distribution box is and sturdy. This distribution box is designed for 3-4 ways circuit breaker.

Electric Box Cover Breaker Enclosure Distribution Box Circuit Breaker

3/8/12/16 Ways Electric Box Cover Breaker Enclosure Distribution Box Breaker Box Enclosure Box Breaker Panel Box Cover Breaker Enclosure Box Material: ABS+ thickened iron bottom Installation



Custom Electrical Panel Cover

KDM is committed to providing comprehensive electrical panel cover solutions, providing you with 30-space, 42-space, 66-space and other standard specifications, suitable for Square D, Siemens and



What are the Components of a Distribution Panel and

The distribution box and distribution cabinet, distribution board, distribution vouchers, etc., are complete sets of devices such as switches and



IP65 ABS Distribution Protection Box, 12 Way Waterproof Circuit

Reduce repetitive work from subtle points, improve work efficiency, and maintain daily safety inspections of power distribution motors ?Suitable for?12 Way electrical panel DIN distribution box provides

Amazon : electrical panel cover Flip Breaker Box Panel Cover

About this item Covers Up Flaws Breaker Panel Cover: Effortlessly hides electrical panels, outlets, or any other wall-mounted gadgets you'd rather keep out of sight, for a cleaner, more



Cover distribution panel , Electrical material , eibabo

Covers for distribution panels ensure a clean, safe, and standards-compliant finish for electrical distributions. They protect live parts from accidental contact, conceal open areas, and support a tidy



2-16 Ways Electric Box Cover Breaker Enclosure Distribution Box

Buy 2-16 Ways Electric Box Cover Breaker Enclosure Distribution Box Strong Current Circuit Breaker Panel online today! Description: Made of good quality plastic material, this circuit breaker distribution



20? Temporary Electrical Panel Cover

20? Temporary Electrical Panel Cover Our Temporary Panel Covers provide are made from translucent PVC to provide an easy way to view the breaker box

Transparent protective cover for electrical distribution boxes , 6

This transparent protective cover is designed for panels and control cabinets, providing maximum protection in demanding industrial and environmental conditions. Made from high-quality

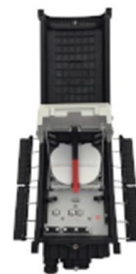

Amazon : Low Voltage Panel Box

Streamline your home wiring and media setup with low voltage panel boxes. Browse enclosures designed for easy installation and cooling of enclosed equipment.



**Plastic cover for distribution boxes -
Distribution box - Distribution**

Details Home > Distribution boxes > Distribution
box > Plastic cover for distribution boxes



Contact Us

For datasheets, pricing, or custom high-speed optical interconnect solutions,
please visit:
<https://www.syropy.com.pl>