

# Telecom Fiber Optic Secondary Distribution Box

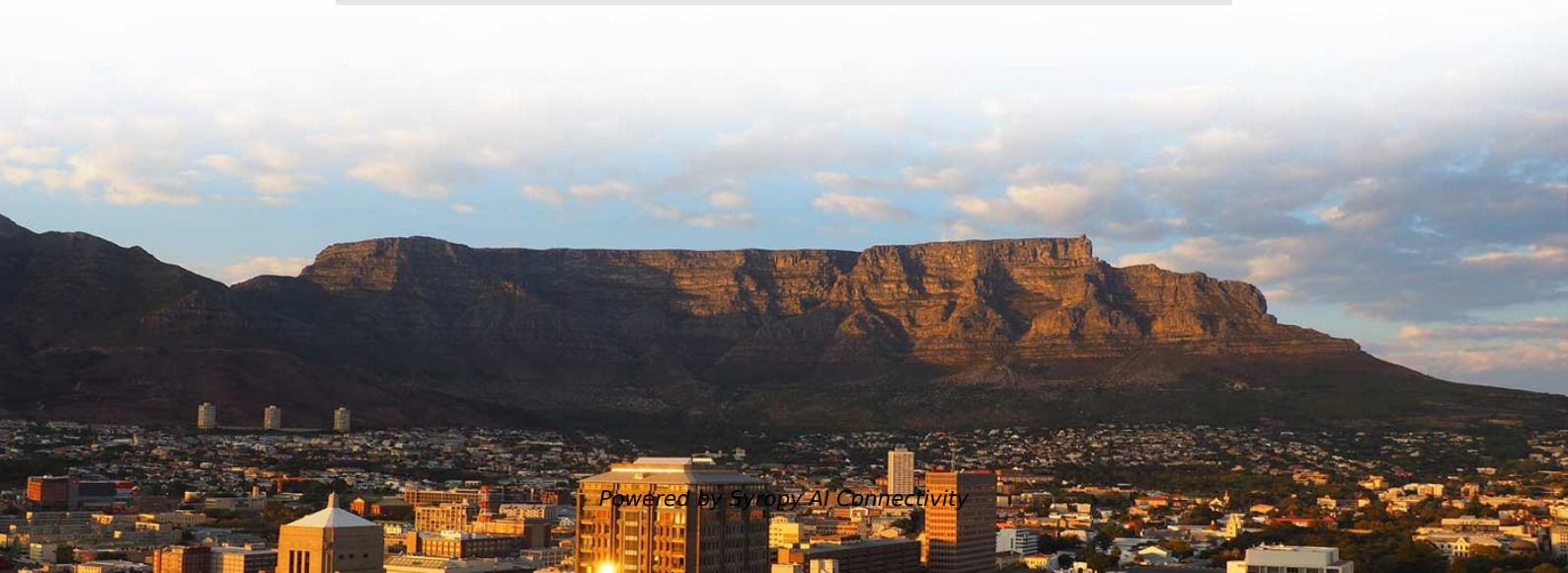



## Telecom Fiber Optic Secondary Distribution Box

---



### Fiber Distribution Architecture

Fiber distribution hardware manages each fiber and connection point that is associated with active electronics. Why do operators, designers, and installers

### How to Choose the Right Fiber Distribution Box for

Selecting the right fiber distribution box (FDB) is a critical decision for any FTTH, FTTB, or campus PON deployment. As the junction point for fiber

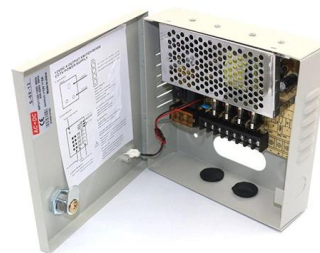

### Fiber Optic Distribution Box Application and Research Report

In Fiber To The Home (FTTH) networks, the optical fiber distribution box is mainly deployed in building corridors, telecom shafts, or outdoor poles, responsible for fiber branching and

### An In-Depth Exploration of Fiber Optic Distribution

This article provides a comprehensive overview of fiber optic distribution boxes, essential components in modern telecommunications networks that enhance data



### **An In-Depth Exploration of Fiber Optic Distribution**

It begins with an introduction to fiber optic technology and the pivotal role of distribution boxes in managing fiber optic cables. The article categorizes the



### **Fiber Optic "Big Three": Termination Box, Distribution**

From a planning and design perspective, this article will give you an organized understanding of the meaning, function, and differences between the



### **How To Use Fiber Distribution Box?**

A fiber distribution box, also called a fiber termination box, is a protective enclosure that connects fiber optic cables from the service provider to





## Fiber Box Solutions for FTTH: Key Functions,

A clear guide to fiber box solutions in FTTH and ODN networks. Learn how fiber boxes support splitting, routing, and efficient deployment for

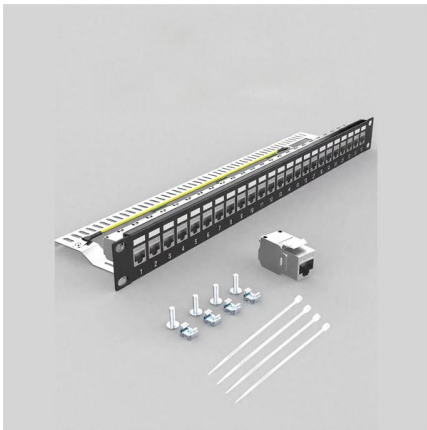

## What Are Distribution Boxes and Their Functions in

Understand the role of distribution boxes in fiber optics. Learn about their components, types, and functions in protecting and managing fiber optic

## The Technical Specifications for Fiber Distribution Boxes

To ensure consistent performance and longevity, it is essential to adhere to strict technical specifications. This article delves into the intricacies of



## SUN-PDN-1201 Series Pre-connectorized Distribution

Sun Telecom's SUN-PDN-1201 series fiber optic pre-connectorized distribution box is used as a distribution point for the feeder cable to connect with the drop cable in

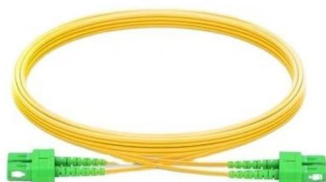



### SUN-ODN-H Distribution Box

Indoor, Max adaptors: 1 / 2, SC, DLC adaptors  
Key Features Indoor flush mount SC adapter panel Fast connector applicable Description Specifications Ordering

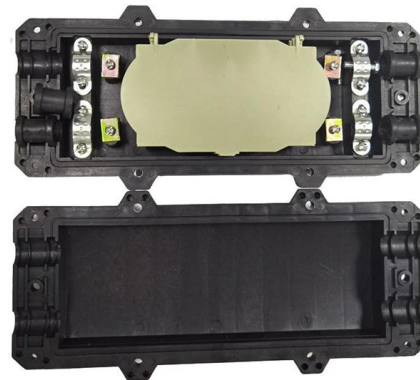

### Optical Fiber Distribution Box , Wall Mount Fiber Solution

Optical fiber distribution box offers secure, organized fiber management with wall mount design. Ideal for FTTH, LAN, and telecom network setups.



### What's Inside a Fiber Distribution Box? Let's Break It Down!

FDBs are specifically designed to safeguard delicate fiber optic connections from environmental and physical damage. By protecting splices, connectors, and cables from dust,



### Fiber Distribution Box & Terminal Box , Top-Quality

Specializing in both copper and fiber solutions, our products are designed for superior performance in data centers and FTTX applications. With over 35 years



## Telecom Indoor 8 Core Optical Fiber Distribution Box

FTB Series FTTH customer terminal box is used in the end termination of residential buildings and villas, to fix and splice with pigtails. We offer the full set of plastic



## Fiber Optic Distribution Boxes (FDB) & ODF Supplier

OTRANS is a leading fiber optic distribution box manufacturer. We offer a wide range of 1-24 core FDB boxes and ODF cabinets for indoor/outdoor FTTH deployment.

## How to Use Fiber Distribution Box: A Comprehensive

A fiber distribution box (FDB) functions as a central hub in fiber optic networks where the main cable is split into multiple individual fibers for distribution



## Fiber Optic Distribution Box

Fiber Optic Distribution Boxes (FDBs) are crucial components in fiber optic networks, serving as junction points for distributing and terminating optical signals. They



### Fiber Optic Distribution Box

The 48 Fibers Distribution Box is a versatile device that can be used to manage and protect fiber optic cables in a variety of applications. It is designed for outdoor use



### Serving area interface

Serving area interface SAI in New Jersey The serving area interface or service area interface (SAI) is an outdoor enclosure or metal box that allows access to telecommunications wiring.

### Fiber Distribution Hub , Fiber Optic Cabinet , Multilink

Contact us for a free quote on a variety of fiber optic distribution hubs. We have rack rail cabinets as well as spice hubs. We also provide custom telecom solutions.

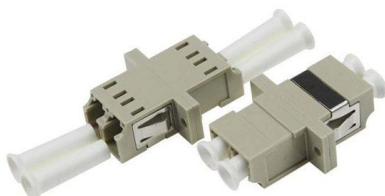
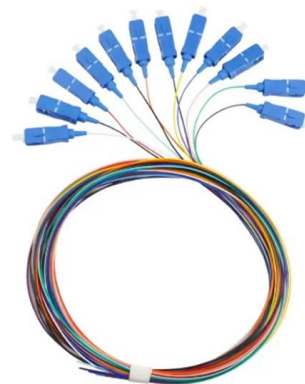

### Optical Distribution Box (ODB) in FTTH Network

Optical Distribution Box (ODB) in FTTH Network: ODB used in FTTH network to provide an intermediate connection or interfacing point between telecom industry main fiber optic entrance



### **FTB/FDB-2180 Fiber Optic Termination / Distribution Box**

Application Applicable for wall-mounted, Indoor or Outdoor rails To be used at home or working area to accomplish double-core fiber access and port output Suitable

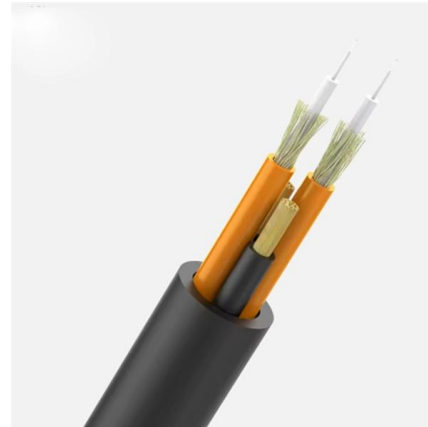

### **Outdoor Fiber Distribution Units - Fiber Savvy**

Fiber Savvy offers an excellent solution for all of your outdoor fiber distribution needs. Our Fiber Optic Cable Distribution Boxes are specially designed to house and protect the various amounts of simplex

### **SUN-PDN-1804 Pre-connectorized Distribution Box**

Sun Telecom's SUN-PDN-1804 fiber optic pre-connectorized distribution box is used as a distribution point for the feeder cable to connect with the drop cable in the FTTx communication network system.

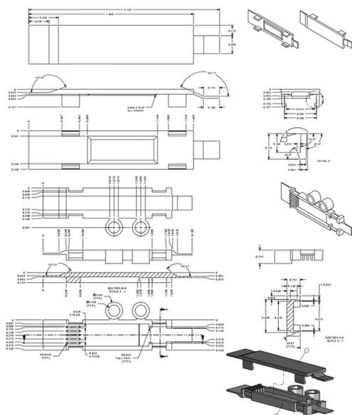
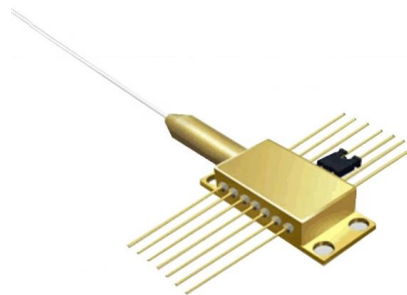

### **SUN-ODN-G2 Distribution Box**

Sun Telecom's SUN-ODN-G2 series fiber optic distribution box is light and compact, especially suitable for protective connection of fiber cables and pigtails in FTTH.



## The Applications And Benefits of Splitter Distribution Box

The optical fiber cable distribution box provides a cost-effective solution for the FTTH network. Currently, some manufacturers supply this type of box with loaded fiber splitters, adapters,



## Fiber Termination Boxes: A Beginner's Guide to

In the dynamic landscape of modern communication, Fiber Termination Boxes (FTBs) play a pivotal role in ensuring the efficiency and

## Contact Us

---

For datasheets, pricing, or custom high-speed optical interconnect solutions, please visit:  
<https://www.syropy.com.pl>