

# **Supply cost of fiber optic communication prisms**

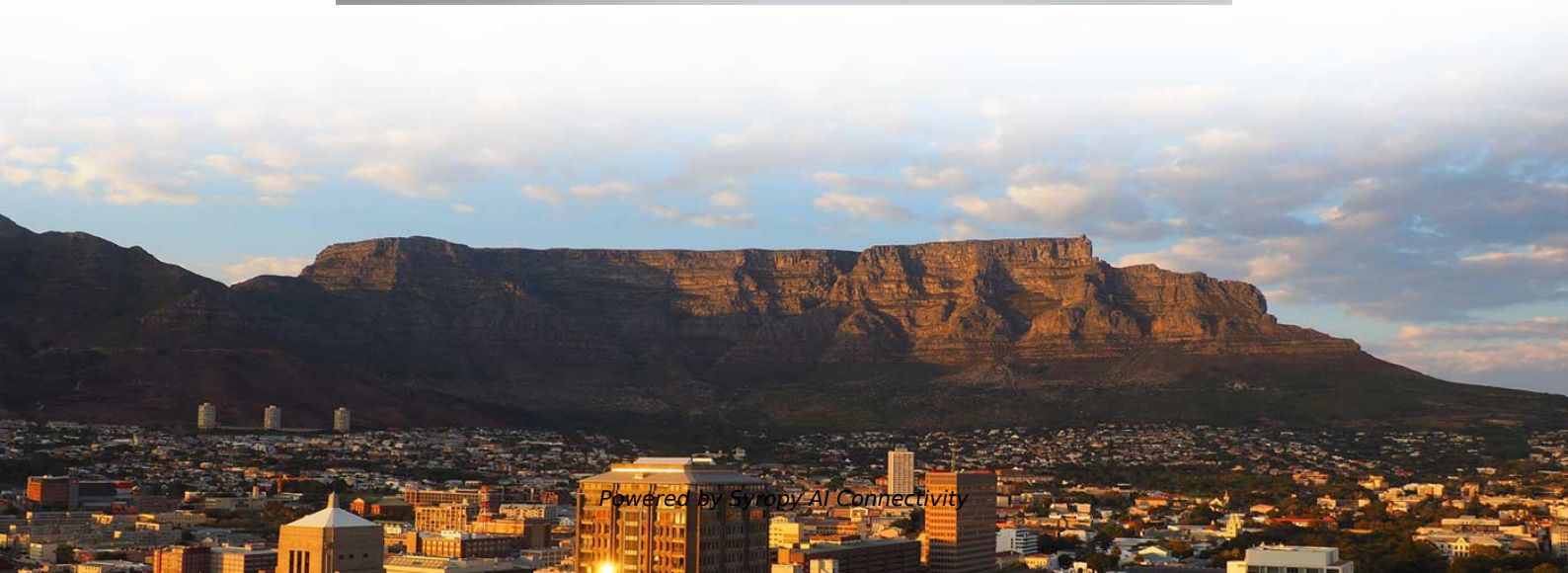

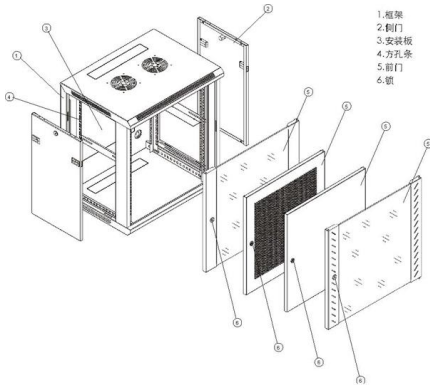

## Supply cost of fiber optic communication prisms



### Optical Cable Pricing: Comprehensive Guide to Cost-Effective Fiber

Explore competitive optical cable pricing options, featuring detailed cost analysis, performance benefits, and long-term value propositions for modern networking infrastructure.

### Fiber Optics , Suppliers , Pricing Trends, Best Practices

The report further delves deep into the aspects of cost structure, total cost of ownership and supplier margins for Fiber Optics. A dedicated section to supplier profiles and evaluation helps decision

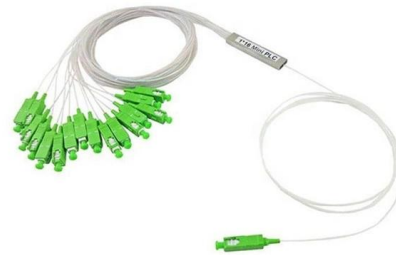

### FTTH Cable Price Per Meter: Complete Guide to Cost-Effective Fiber

Comprehensive analysis of FTTH cable pricing, including cost factors, advantages, and quality considerations for fiber optic network deployments. Learn about per-meter pricing benefits and



### Fiber Optics Market Size, Share, Growth , Forecast

The global fiber optics market size is projected to grow from \$9.81 billion in 2026 to \$21.16 billion by 2034, at a CAGR of 10.10% during the forecast



### Fiber Optic Components Market Report 2025

Optical fiber components are crucial components for communications and networking. Fiber optic components allow the core networking hardware, such as



### Optical Fiber Raw Material Market: Industry Analysis

The soaring price of basic materials has put pressure on optical fiber and cable material manufacturers, and it has also brought pressure on optical fiber and



### Sky-High Prices Contribute to Rising Fiber Optic Cable Costs

This executive briefing on trade (EBOT) will examine the relationship between fiber optic cable input costs, specifically silica tetrachloride, helium, and energy, and the demand forces that have



## Are Optical Prisms Compromising Fiber Optic Communication

In simple terms, optical prisms are transparent blocks of glass or other materials that bend and refract light. This bending of light can be harnessed in various applications, including fiber optics, to manage



## How Much Does Fiber Optic Cable Cost?

See our methodology and corrections policy. Fiber optic technology has revolutionized modern communications by enabling incredibly fast data

## Cost of Fiber Optic Cable: Pricing Guide (2026)

Discover the cost of fiber optic cable in this pricing guide. Learn material prices, installation factors, and what impacts total project costs overall.



## Fiber Deployment Cost Annual Report

The Fiber Broadband Association has partnered with Cartesian to research the cost of deploying fiber and provide insight on how these costs are evolving over time.



### in the Current Fiber Broadband Supply Chain UPDATE

Introduction The national transition to fiber broadband is well underway and progressing rapidly, with over 60.5 million households currently being served by fiber, an increase of 12% in 2021. This



**Wiley Online Library , Scientific research articles, journals, books**

Hier sollte eine Beschreibung angezeigt werden, diese Seite lässt dies jedoch nicht zu.



### The keys to deploying fiber networks faster and cheaper

The nerve center established by one operator detected a delay in the delivery of specialized fiber-optic cables from a key supplier. Procurement

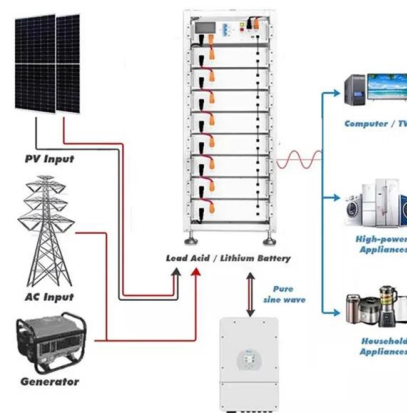

### The U.S. is investing in fiber-optic internet. Here's what

The U.S. is investing billions of dollars in fiber internet. Here's what makes it run. We tour a North Carolina plant where melted glass is pulled into the

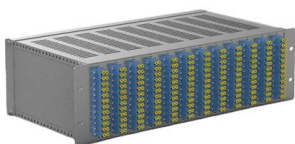

### Fiber Optic Cable Market Size



The Fiber Optic Cable Market worth USD 14.22 billion in 2026 is growing at a CAGR of 9.84% to reach USD 22.74 billion by 2031. Corning Inc.,



### Fiber Optics Market Size & Share , Industry Report, 2033

Fiber Optics Market Summary The global fiber optics market size was estimated at USD 10.76 billion in 2025 and is projected to reach USD 17.95 billion by 2033,



### Producer Price Index by Industry: Fiber Optic Cable

Graph and download economic data for Producer Price Index by Industry: Fiber Optic Cable Manufacturing: Fiber Optic Cable, Made from Purchased Fiber Optic Strand



### Key Considerations When Purchasing Optical Prisms for Communication

Acquiring the right optical prisms for fiber optic communication can greatly impact system performance. By considering material quality, prism type, technical specifications, supplier reputation, cost versus





## Producer Price Index by Industry: Fiber Optic Cable

U.S. Bureau of Labor Statistics, Producer Price Index by Industry: Fiber Optic Cable Manufacturing: Fiber Optic Cable, Made from Purchased Fiber Optic Strand ,

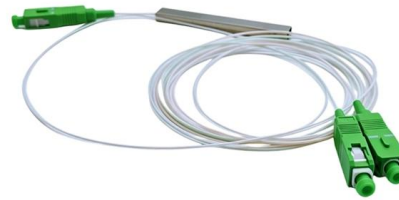

## Unlocking Speed: How Optical Prisms Revolutionize Fiber Optic Communication

Fiber optic communication utilizes light to transmit data over long distances at incredible speeds. It relies on fiber optics--thin strands of glass or plastic--capable of guiding light with minimal loss. However,

## Fiber Optic Cable Pricing Guide: Factors That Affect Cost

This guide outlines the major factors that influence fiber optic cable costs and provides practical tips for estimating pricing in bulk or project-based scenarios.



## Fiber Optic Cable Price: Understanding the Cost of

In fiber optic technology, the fiber optic cable price is a crucial factor for businesses, service providers, and individuals upgrading to fiber optic cables.



## Key Factors of Fiber Optic Price How Much Does It

The global dynamics of supply and demand for fiber optic cables significantly influence their price. On the supply side, factors such as availability



## How Much Does It Cost to Run Fiber Optic Cable per

How Much Does Fiber Optic Installation Cost Per Foot? Cable Material Costs: Standard single mode fiber: \$0.09-\$1.49 per foot Multimode fiber

## McKinsey Direct Opportunities in networking optics: Boosting supply

-- Coherent-lite optics. This technology delivers cost-effective, lower-power coherent transmission for shorter reaches--such as data center interconnect and metro inter-data center optics (front

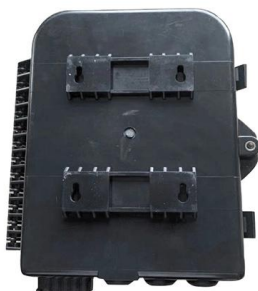

## Rising Fiber Optic Prices and Supply Challenges: Cost Trends

Historical data shows that optical fiber prices rebound after several years of troughs, with some periods seeing rebounds of approximately 70% from their lows, while delivery times also



## Comprehensive Guide to Fiber Optic Cable Pricing: Features, Benefits

Explore detailed insights into fiber optic cable pricing, including performance benefits, cost-effectiveness, and long-term investment value. Learn about installation economics and maintenance considerations

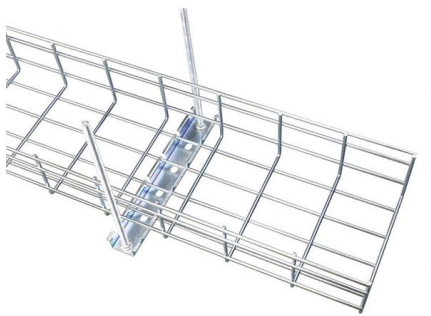

## Unit Economics of Fiber Optic Investments

Investing in fiber optic networks involves two main cost categories - capital expenditures (CAPEX) and operating expenditures (OPEX) - both of which

## Contact Us

---

For datasheets, pricing, or custom high-speed optical interconnect solutions, please visit:  
<https://www.syropy.com.pl>