

Sudan 6-core smart building optical cable factory





Sudan 6-core smart building optical cable factory



Sudan Fiber Optic Cable Market (2025-2031) , Companies & Forecast

The Sudan Fiber Optic Cable Market is projected to witness mixed growth rate patterns during 2025 to 2029. Beginning strongly at -9.49% in 2025, growth softens to -15.80% in 2029.

Subsea Fibre

The Eastern Africa Submarine Cable System (EASSy) is an undersea fibre optic cable system connecting countries in Eastern Africa to the rest of the world.



Sudan Fiber Optical Cable and Cable Assembly Products Market

6Wresearch actively monitors the Sudan Fiber Optical Cable and Cable Assembly Products Market and publishes its comprehensive annual report, highlighting emerging trends, growth drivers, revenue

Bayobab to deploy fiber in South Sudan

Bayobab, a digital connectivity solutions company, has announced plans to build a fiber optic cable network across South Sudan.



MEFC - Rakami

MEFC manufactures various types of fiber optic cables by taking into account the customers' requirements, the latest technologies and the highest quality. MEFC



SES ELECTRIC COMPANY - The Best Energy Solution

S.E.S Electric Company is ranked among the top companies In solidarity with our shareholders as Sudanese Electric Transmission Company (SETCO), providing the best quality of full-service energy



Al-Multaqa ::: .

A. JOUD CABLES - Sudan Joud Cables was established in 2006, to provide the Sudanian Market with Cables and Electric wires .The Company is manufacturing a bare copper conductors and insulated





Sudan Fibre Optic Cables Market (2025-2031) , Outlook Growth

6Wresearch actively monitors the Sudan Fibre Optic Cables Market and publishes its comprehensive annual report, highlighting emerging trends, growth drivers, revenue analysis, and forecast outlook.



Al-Multaqa :::

The company is located in the industrial zones in Sudan Albaqir. Joud considers one of the leading companies in manufacturing of wire and cable, the company is provided with the latest machines and

Project Brief

The EASSy is an initiative to construct and operate a submarine fiber-optic cable along the east coast of Africa to connect 20 coastal and land-locked countries to each other and to the rest of

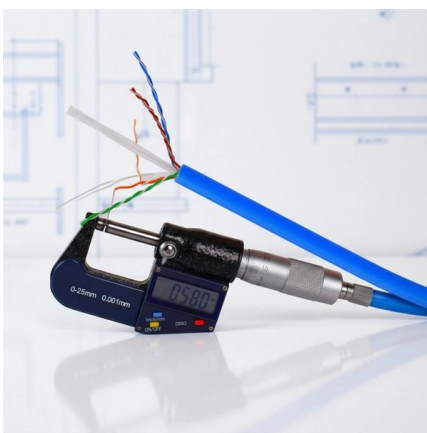
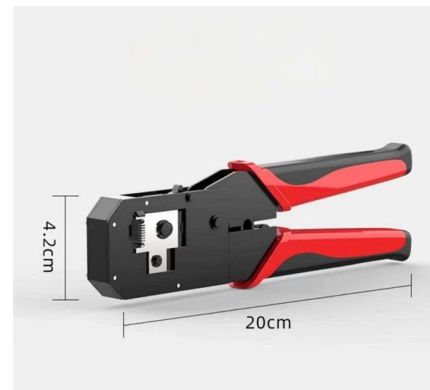

Internet Connectivity , Smart Network Ltd.

South Sudan's best internet service provider, offering fully dedicated, super-fast, cost-effective, and secure internet connections.

Giad Group for Engineering Industries



Giad Industrial Group was established in the year 1993 AD with a vision to be the largest industrial group in Africa. In accordance with a vision that leads the



Sudan's Telecommunications Sector Revitalized with \$3

Sudan's telecommunications infrastructure is set for a major transformation following a \$3 million investment in advanced networking

World's longest subsea cable 2Africa reaches Saudi

RIYADH: Saudi Arabia is now connected to the world's longest subsea cable after the 45,000-km fiber-optic 2Africa network landed in Jeddah and

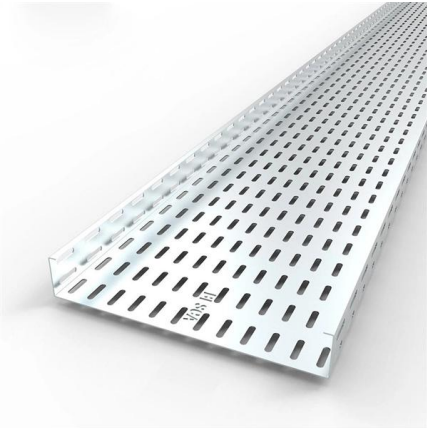
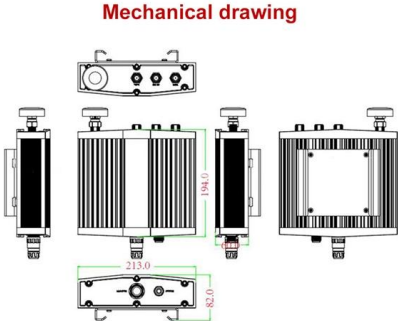

Fiber Optic Internet South Sudan , IPTEC High-Speed

At IPTEC Limited, we deliver the fastest, most reliable, and most secure internet connectivity in South Sudan through our state-of-the-art Fiber Optic Network.



NCA, Sudatel to lay fibre optics in Unity State

A worker fixing underground fibre optics cable -Courtesy photo By William Madouk Garang The National Communication Authority (NCA) and a



- IP65/IP55 OUTDOOR CABINET
- OUTDOOR CABINET WITH AIR CONDITIONER
- OUTDOOR ENERGY STORAGE CABINET
- 19 INCH

About Us -- MAZAR INTERNATIONAL

Mazar International Co. Ltd. is a Sudanese engineering and infrastructure company established in 1993. With over three decades of experience, we have earned our place as a leader in civil construction,

Network Infrastructure - Via Service Co

VIA is a full-service network cabling provider with the resource to design and implement structured cabling in SUDAN. Providing network cabling service



South Sudan, World Bank set to launch fiber optic

South Sudan's government, in collaboration with the World Bank, has announced plans to lay a high-speed fiber optic cable from Kenya in early 2026,



Sudan's Telecom Infrastructure Bolstered by Fibre Optic Connectivity

Sudan's national fibre optic backbone and international fibre connections have placed its telecommunication infrastructure among the regional frontrunners according to a report by Research

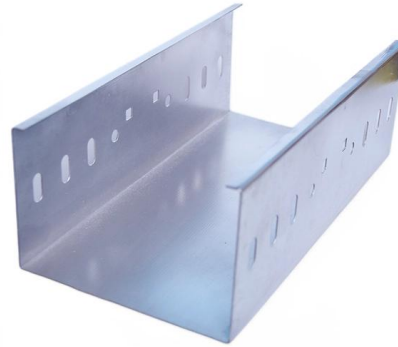

CONDUCTOR BUILDING SERVICES ENGINEERING COMPANY

Design and build including over head & under ground of FO Link. Testing and commissioning of Fiber Optic Cable link (Optical Time Domain Reflect Meter Test, Optical Power Test and Splicing &

OUR ENERGY PRODUCTS - SES ELECTRIC COMPANY

The Factory Manufactures All Kind Of Aluminium Conductors : -ACSR (Aluminium Conductor Steel Reinforced), -AAAC (All Aluminium Alloy Conductor), -ABC

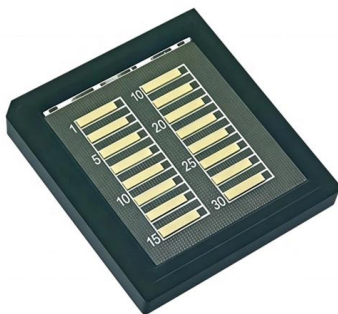
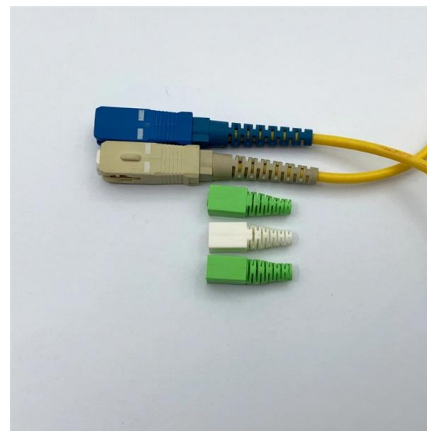

SooPage

SooPage is a professional and free Sudan business directory website, We index and show Sudan companies detailed information Looking for a Sudan Business? The online business directory lists



Bayobab plans to deploy fiber optic network in South

Bayobab, the wholesale fiber optic subsidiary of MTN Group, plans to build a fiber optic cable network across South Sudan. The company presented



Canar

Our extensive infrastructure combines submarine cables, satellite systems, and a robust fiber optic network spanning across Sudan. This integrated approach ensures seamless communication,

Contact Us

For datasheets, pricing, or custom high-speed optical interconnect solutions, please visit:
<https://www.syropy.com.pl>