



Syropy AI Connectivity

Standard Requirements for Secondary Distribution Boxes in Shopping Malls





Standard Requirements for Secondary Distribution Boxes in Shopping

Department of Trade and Industry Philippines

Hier sollte eine Beschreibung angezeigt werden, diese Seite lässt dies jedoch nicht zu.



Power Distribution Boxes Explained Simply

Discover the essentials of a Power Distribution Box--how it works, key types, benefits, and tips to ensure safe, efficient electrical power management.



Shopping Mall Design Standards , PDF , Stairs

This document provides standards and guidelines for shopping malls and retail stores. It discusses column spacing, store depths, clear heights, parking ratios,

Shopping Mall Design and Guidelines

The document provides information on various design requirements and guidelines for buildings and facilities including parking, ramps, entries and exits, lifts,



Power Distribution Boxes Explained Simply

Learn what a power distribution box is, how it works, key components, types, and why it's vital for safe and efficient electrical systems.



Data collection of malls , PDF

The document outlines guidelines for architectural design and standards specific to shopping malls, focusing on various aspects such as store layout, merchandising principles, customer traffic

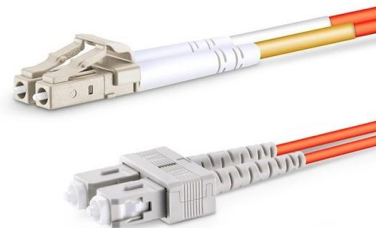

NFPA 101 and Malls

The criteria include requirements for minimum clear width for the mall concourse, minimum widths for exits, automatic sprinklers, construction of walls between tenants, and smoke

The Meaning and Function of Primary,



Secondary, and Tertiary

Follows the principle of "one machine, one switch, one RCD, one box, one lock," ensuring no single switch controls multiple devices. This explanation aims to clarify the roles and functions of



ABB , Building Solutions , Retail and Mall

Building Solutions for Retail & Mall Retail is today an omnichannel experience. Have you ever wondered how technology can support you in creating an integrated

Layout of a functioning shopping mall, illustrating

Secondly, for the purpose of suggesting a new shopping mall layout, this study has taken into account a number of vital factors which were not previously considered

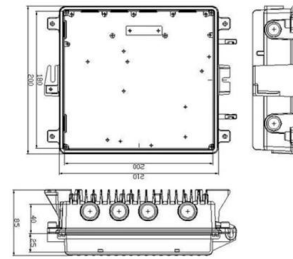
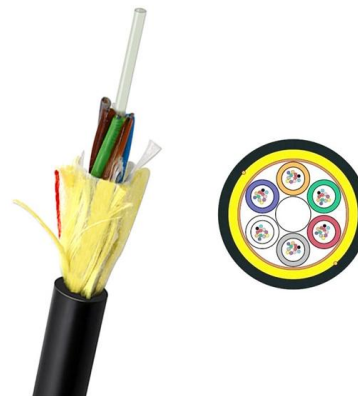

Building Electrical Solutions

L& R Electric's shopping mall power distribution system solution is an overall solution designed for low-voltage power distribution systems in shopping malls. The



An Investigation of Shopping Mall Design Requirements

In this study, we examine the relationship between three factors (tenant variety, mall environment and shopping involvement) on shoppers'

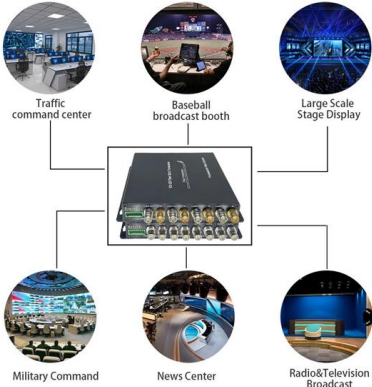

Mall Design and Dimension Standards , PDF , Stairs

The document provides guidelines for various design considerations for retail buildings and common spaces. It discusses dimensions for column spacing, store

Shopping Mall Design Standards

Comprehensive standards for shopping mall design, including store dimensions, parking, circulation, and mechanical systems. Ideal for architects and engineers.

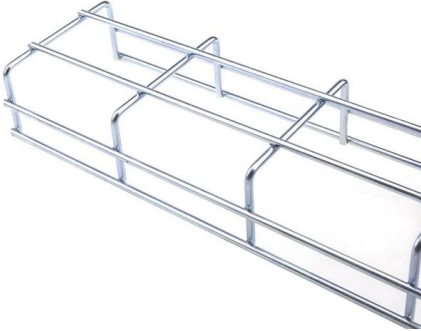
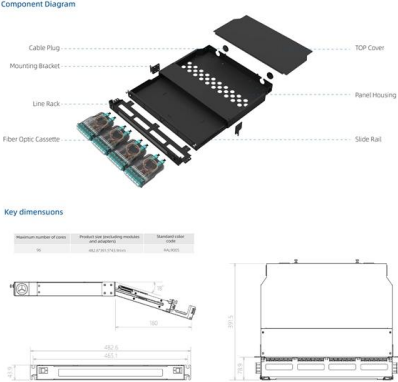

Commercial Shopping Mall Plans and Design

Explore expert tips for commercial shopping mall design, layout planning, and modern retail architecture. Learn zoning, circulation, and sustainability strategies.

Security Conditions and Requirements of



the Shopping Centers

Chapter 1: Standard and Technical Specifications of the Security Systems Application of Standard and Technical Specifications of Security Systems of Law No. (12) of 2016, issued in February 2022, on



LOVE OUR LOCAL SHOPPING

Additional requirements, for example security mesh above inter-tenancy walls, or extending walls full height to allow for an open plan ceiling, are undertaken at your cost. Where applicable, building



Retail Distribution Center Design: The Essentials

This blog post dives into the key design considerations for modern retail distribution centers, exploring strategic planning, innovative automation



An Investigation of Shopping Mall Design Requirements

During the interviews, we collected insights on shopping mall design and criteria that have an impact on the operational success or failure. We



Design Principles and Practices

Architect is being affected with external influences - public or private owner, community, regulations, environmental concerns, tenants retail requirements - trying to shape architect's services.



352967258-Standards-for-Shopping-Mall-Ppt.pdf

This document provides standards and guidelines for shopping malls, including column spacing, store depths, clear heights, parking ratios, and the effects of

RETAIL DESIGN GUIDELINES

Guidelines illustrate the optimum dimension for all new developments. All existing developments to comply with the Design Guideline principles and dimensions to be confirmed on site.

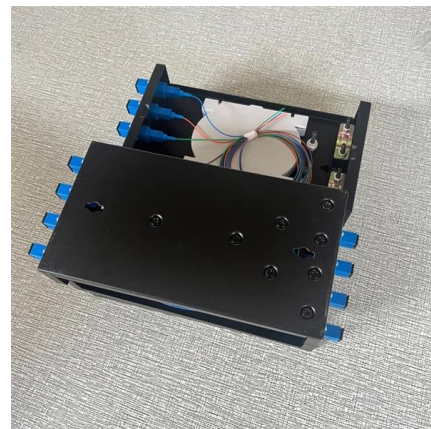

Complete Guide to Commercial Distribution Panels [May

Learn how commercial distribution panels work, their key parts, types, and how smart features and maintenance ensure safe, efficient power management.



How to Organize a Commercial Space?



Distribution and

Cite: Iñiguez, Agustina. "How to Organize a Commercial Space? Distribution and Circulation Strategies in the Design of Stores and Premises"



Shopping Mall Size and Layout Standards

The document provides standards and guidelines for shopping malls, stores, and circulation areas. It addresses column spacing, store depths and heights, parking

Shopping Mall Construction

Shopping Mall Construction Shopping Mall Construction and Design Guide - Technical Specifications Spatial Planning Mall Configuration Structural Systems Floor Loading Requirements Technical



Shopping Mall Construction

Every contribution fuels new features and improvements. Thank you for being part of our journey!



Contact Us

For datasheets, pricing, or custom high-speed optical interconnect solutions, please visit:

<https://www.syropy.com.pl>