

Southern European Outdoor Distribution Box Brand Manufacturer

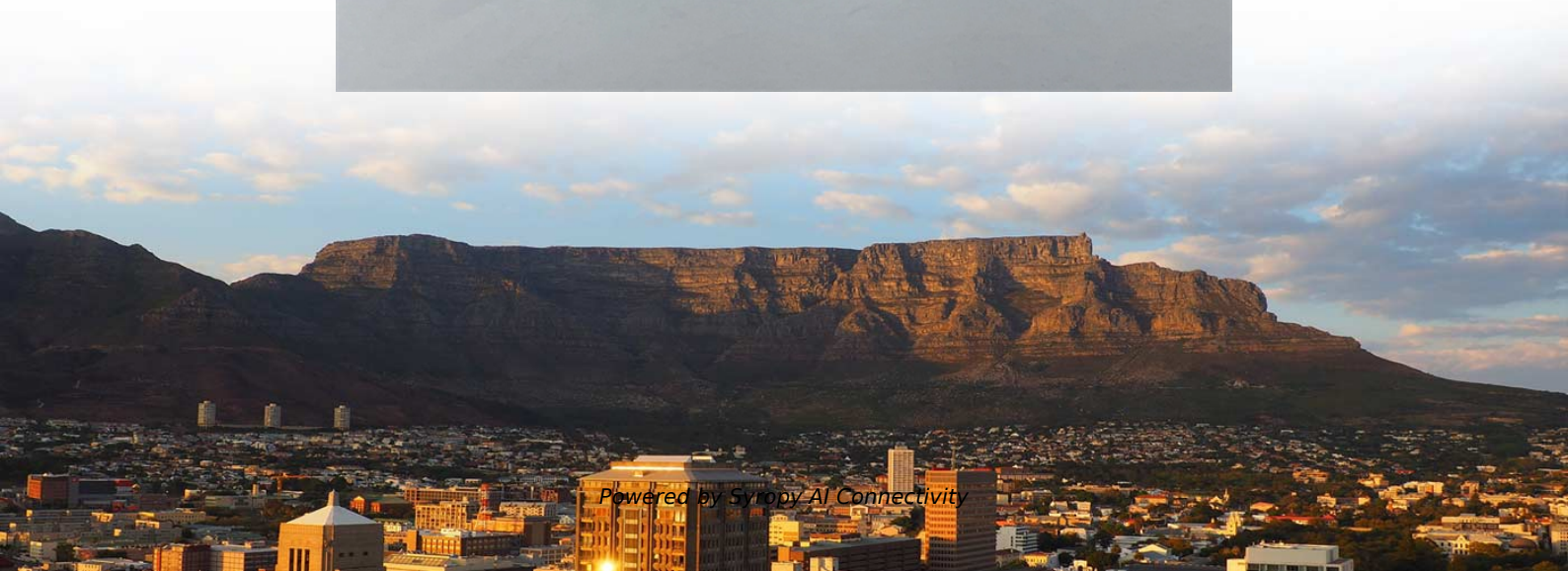

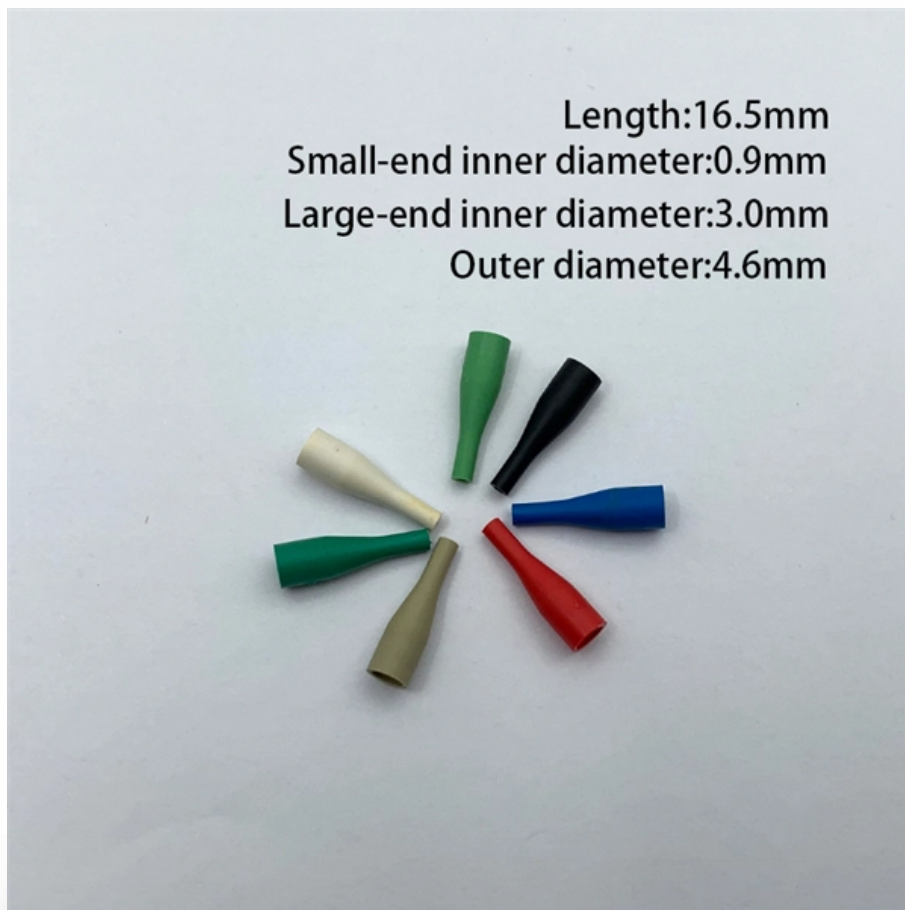

Southern European Outdoor Distribution Box Brand Manufacturer

European-style Outdoor Box-type Substation



Prefabricated substations, modular substation, wind power substation, low voltage switch cabinet and power transmission and distribution equipment, products widely used in electric power, railways,

Distribution Box Solutions for Every Industry

Explore SENTOP's high-quality Distribution Box, designed for residential, commercial, and industrial applications at competitive prices.

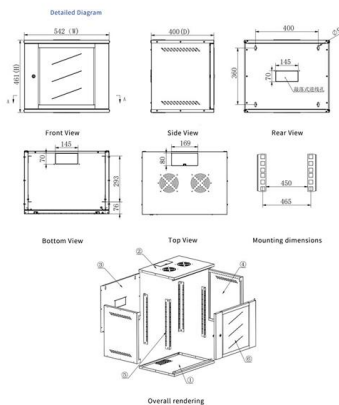

Power Distribution Box Manufacturer and Supplier

GEYA is an experienced distribution box company generating significant income because of our client-centric product designs, which were made feasible by our

Outdoor Distribution Box SHA Series

The SHA series of outdoor power distribution boxes is a multi-functional power distribution equipment suitable for indoor and outdoor environments. It is made of



Top 10 distribution box manufacturers and suppliers you should know

The right distribution box does more than route electricity - it protects investments and lives. Whether upgrading an office building or securing a manufacturing plant, these top manufacturers combine



Outdoor Box

Manufacturer of Outdoor Box - A.C. Outdoor Box, W/PF 4 Way Outdoor Box, W/PF 2 Way Outdoor Box and W/PF A C Box offered by Shivshakti Engineering, Mumbai,

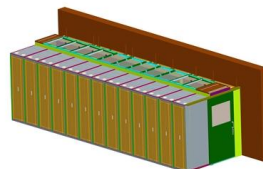

Outdoor Electrical Enclosure Box

Outdoor Electrical Enclosure Box, Find Details and Price about Distribution Box Mild Steel Distribution Box from Outdoor Electrical Enclosure Box - Wenzhou Xujie





IDE Electric

Used to house electrical or electronic switchgear, control gear and equipment necessary to supply, distribute and transform electricity. Made with materials of



Outdoor enclosure, Outdoor box

Find your outdoor enclosure easily amongst the 418 products from the leading brands (ELMA, HUBER+SUHNER, RITTAL,) on DirectIndustry, the industry specialist for your professional



Outdoor Cable Distribution Box, Cable Distribution Box

Weatherproof outdoor cable distribution boxes with IP65 rating, arc-proof design, and flexible terminations for safe, reliable power distribution up to 10kV.



Cable Distribution Box for Outdoor Distribution

Our Cable Distribution Box is pre-engineered for easy installation and operation. It includes fault interrupters, vacuum switches, and fuse options inside a compact,



Electrical Distribution , DKC Europe

Established in 1998, DKC Group has become a leading manufacturer of cable tray systems and energy protection, transport and distribution solutions for civil and

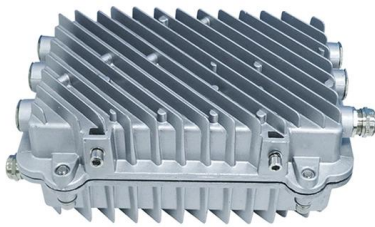
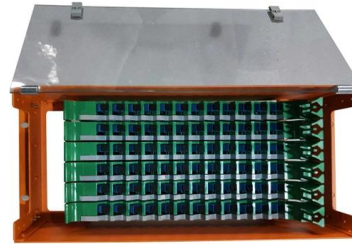

Top Distribution Board Manufacturers in 2024 , TOSUNlux

After extensive research, we've identified the top eight distribution board manufacturers leading the way in 2024. These distribution board

17 AC Distribution Box Manufacturers in 2026

This section provides an overview for ac distribution boxes as well as their applications and principles. Also, please take a look at the list of 17 ac distribution box manufacturers and their company rankings.



Professional Electrical Box & Distribution Box Manufacturer

From residential and industrial to photovoltaic applications, see how SKKBO designs electrical products that are trusted worldwide. Compact and safe



Dahua DH-PFM377 Outdoor Distribution Box for Pole Mount, IP54

Introducing the Dahua DH-PFM377 Outdoor Distribution Box, designed specifically for pole mounting. This robust enclosure is rated IP54, ensuring reliable protection against dust and water, making it



Cable Distribution Box, Outdoor Cable Junction Box

DOHO is a leading cable distribution box manufacturer and supplier. We cater to applications including industrial, data center, security, and telecommunications.



Distribution boxes electrical installation Germany , B2B

Development, manufacturing, and distribution of flow and flow measurement technology, even for extreme applications, in all industrial sectors. Own DAkkS-accredited calibration laboratory.



outdoor distribution boxes , uesa GmbH

The catalogues for the meter connection columns and street lighting distributors are ordered according to the distribution system operator. You will be sent the current gross price lists (Status 01.04.2021)





Top 10 Electrical Enclosure Manufacturers Globally in 2025

Top 10 Electrical Enclosure Companies Making a Change in 2025
1. Hammond Manufacturing
Hammond Manufacturing is a top manufacturer of high

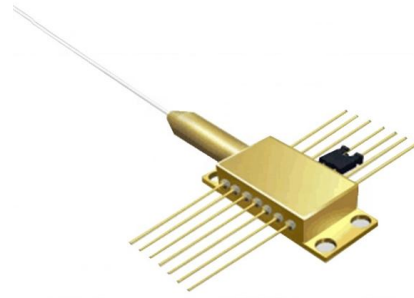

`display/node_modules/zxcvbn/dist/zxcvbn.js.map`

Gestion des collections d'échantillon -
management of samples collections

Waterproof Distribution Box Manufacturer , IP65/IP66

SELHOT's plastic power distribution boxes (plastic distribution boards) are impact and oxidation resistant, making them ideal for use in waterproof and dustproof



Top 6 Distribution Box Makers with Innovative Features in 2025

See the best distribution box manufacturer picks for 2025, featuring top brands with advanced safety, smart features, and global certifications.





Distribution Boards

Kabeldon distribution boards are specifically designed for outdoor installations and they come as pre-assembled systems, ready to install. They combine the advantages of the flexible IP-system with



Contact Us

For datasheets, pricing, or custom high-speed optical interconnect solutions, please visit:
<https://www.syropy.com.pl>