

Singapore Customs Brokerage Agent Silicon Photonics Technology QSFP

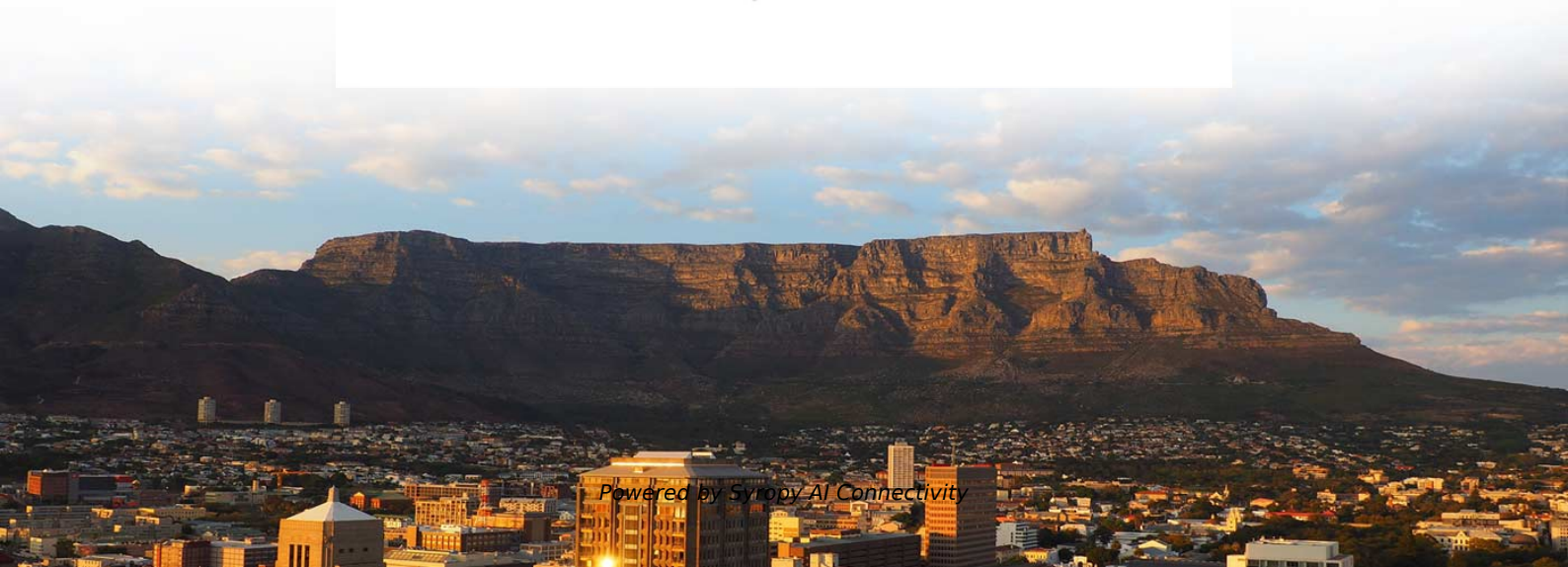



Singapore Customs Brokerage Agent Silicon Photonics Technology C



Top 91 Silicon Photonics Companies in Singapore

Experts in III-V Transceivers & Silicon Photonics for Data Centers, Servers, 5G Open RAN, and UHD video transmission. The company offers a range of high-quality

Roadmapping the next generation of silicon photonics

We chart the generational trends in silicon photonics technology, drawing parallels from the generational definitions of CMOS technology. We



Silicon Photonics , Compoundtek Pte Ltd

Dedicated 8" Silicon Photonics enhanced foundry services with world class production capabilities. CompoundTek was established by industry & technology experts to focus on Silicon Photonics. To

SINGAPORE SCALEUP SILITH TECHNOLOGY One of

SINGAPORE SCALEUP SILITH TECHNOLOGY One of the newest Optica corporate members is Singapore scaleup SiLith Technology, a 70+ person company

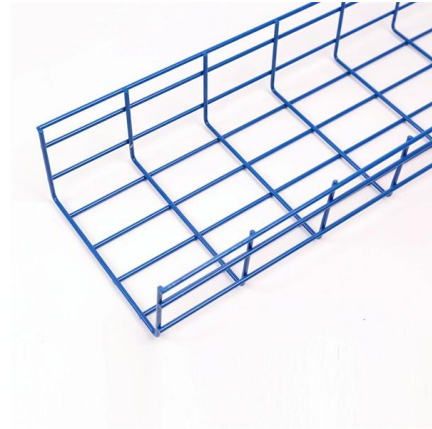

Top 10 companies in Silicon Photonics Market in 2023

Rockley Photonics - Revenue [US\$47 Million] For high-volume optics applications, Rockley Photonics is a fabless supplier of silicon photonics chipsets,

SILITH

Proprietary high-speed silicon MZM and hybrid polymer modulators achieving >70 GHz bandwidth. Optimized low $V \cdot L$ (<1.5 V·cm) design with advanced traveling

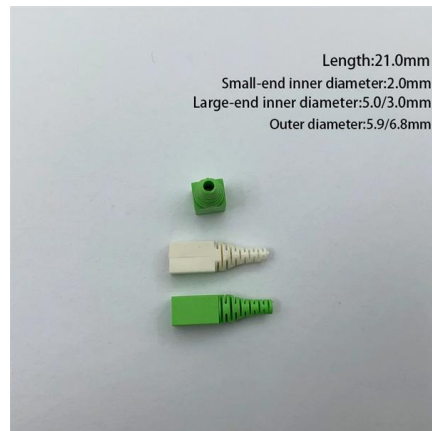

Rain Tree Photonics

Leveraging deep Silicon Photonics expertise, RTP employs a Design for Manufacturability (DFM) approach and operates on a fabless++ business model,



Silicon Photonics Market Size, Share , Industry Report

The scope of this market focuses exclusively on silicon photonics technology, including silicon-on-insulator (SOI) platforms and related integration approaches. It excludes purely discrete

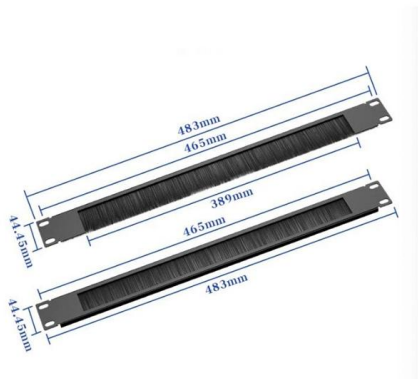

Silicon Photonics: The Future of High-Speed Optical

Discover how silicon photonics enables high-speed, energy-efficient optical communication by integrating photonics and silicon

DustPhotonics Announces Industry-First Merchant 800G

About DustPhotonics: DustPhotonics is a leading developer of silicon photonics technology and solutions for hyperscale data centers and AI applications.

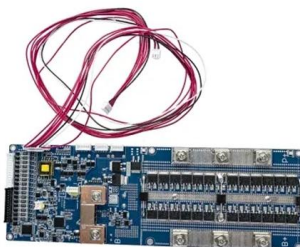

Silicon Photonics Market Size & Share Analysis

The Silicon Photonics Market worth USD 3.96 billion in 2026 is growing at a CAGR of 27.19% to reach USD 13.18 billion by 2031. Intel



A*STAR & GlobalFoundries Collaborate on Silicon Photonics in

A*STAR and GlobalFoundries partner to advance silicon photonics, boosting Singapore's semiconductor innovation.



NSTIC - Semiconductor R& D & Innovation Centre in

NSTIC Singapore drives semiconductor innovation and R& D in Singapore, specialising in photonics and wafer fabrication.



Roadmapping the next generation of silicon photonics

What will the next generation of silicon photonics look like? What are the common threads in the integration and fabrication bottlenecks that silicon



Company Overview

As a leading global provider of advanced technology solutions for communications and data connectivity, we add value to our customers by developing next





Customs Brokerage

Efficient customs clearance services in Singapore. We handle import/export permits, Zero-GST schemes, duty assessments & FTA compliance. Get support today.



Silicon Photonics Market Size Report 2025

As silicon photonics technology advances towards miniaturization and integration, thermal effects have become a significant challenge. The dense integration of

FS Community

Hier sollte eine Beschreibung angezeigt werden, diese Seite lässt dies jedoch nicht zu.



Asia Photonics Expo

Asia Photonics Expo (APE 2027) 3 - 5 March 2027 , Sands Expo and Convention Centre, Singapore
APE 2026 was a remarkable success and brought together



ZECOTEK PHOTONICS SINGAPORE PTE. LTD.

Find company research, competitor information, contact details & financial data for ZECOTEK PHOTONICS SINGAPORE PTE. LTD. of Singapore. Get the latest business insights from Dun &

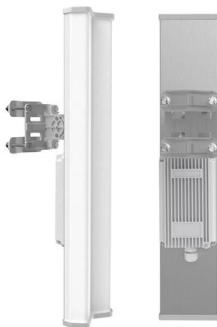

DustPhotonics Announces Industry-First Merchant 800G Silicon Photonics

DustPhotonics, a leading developer of silicon photonics technology and solutions for hyperscale data centers and AI applications, today announced the industry's first merchant single-chip 800G DR8 PIC

Customs Broker Singapore , Declarators

A customs broker Singapore is a licensed professional or company that acts as an intermediary between your business and Singapore Customs. Their primary role

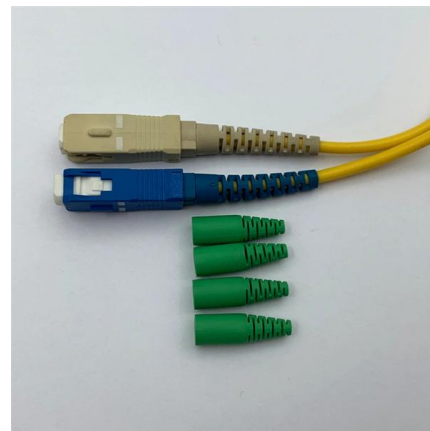

GlobalFoundries Acquires Singapore-Based

GlobalFoundries today announced its acquisition of Advanced Micro Foundry (AMF), a Singapore-based silicon photonics foundry. According to the



HENGTONG GROUP CO.,LTD.

On March 26th 2021, Hengtong Optic-Electric Co., Ltd. convened a new product launch. Its subsidiary company Hengtong Rockley Technology Co., Ltd. moved forward to enrich its high-speed transceiver



Silicon Photonics Companies

Silicon Photonics industry insights on factors that are driving the growth of the Silicon Photonics Market and key players along with their go to market strategies and new revenue sources.

The Last Mile Technology of Silicon Photonics Toward Productions

In this chapter, instead of reviewing the standard CMO-based silicon photonics technology, we focus on the last mile technology toward production, namely the silicon photonics



Electronic Component Distributor Singapore

Headquartered in Singapore FABtronics is a leading Distributor and Global Supply Partner of Franchise Quality Electronic Components and Semiconductor

CompoundTek Opens SouthEast Asia's First



CompoundTek, a global foundry services leader in emerging silicon photonics (SiPh) solutions, has launched its maiden SiPh (silicon photonics) test



Silicon Photonics Jobs in Singapore

Find your ideal job at Jobstreet with 757 Silicon Photonics jobs found in Singapore. View all our Silicon Photonics vacancies now with new jobs added daily!

Contact Us

For datasheets, pricing, or custom high-speed optical interconnect solutions, please visit:
<https://www.syropy.com.pl>