

Romanian rack switcher KVM configuration

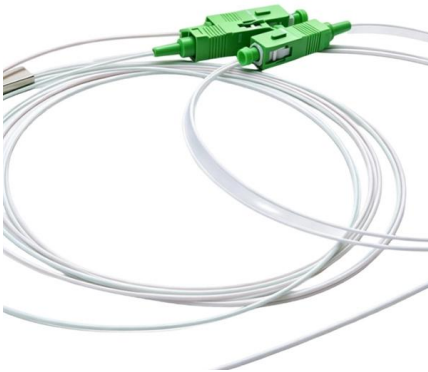



Romanian rack switcher KVM configuration



Dominion KX III Quick Setup Guide

Dominion® KX III Quick Setup Guide Thank for choosing the Dominion KX III, the industry's highest performance enterprise-class, secure, digital KVM (Keyboard, Video, Mouse) switch. This Quick

How to Configure a NetCommander 1U Cat5 Rack-Mount KVM Switch

Audio tracks for some languages were automatically generated. Learn more This 10-minute tutorial gives a detailed overview of the steps for configuring a 1U Cat5 rack-mount KVM switch for server

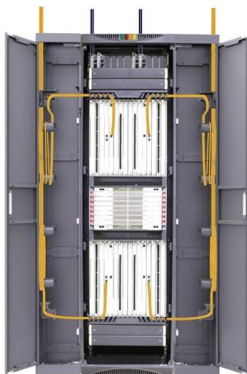

Rack KVM Switches , ATEN Corporate Headquarters

Check our ATEN products: KVM, Professional Audio/Video, Energy Intelligence Rack PDU, Mobility & USB, Data Communication and Cables. , Rack KVM Switches , ATEN Corporate Headquarters

19 Widescreen Rack-Mount Console with Built-In PRO3 KVM Switch

Designed to give you control over multiple servers, the Rack-Mount Console provides an excellent solution for the server administrator. It outperforms any other rack console with KVM switch on the



Switch KVM Preturi, Oferte, Switchuri KVM Magazine, Switchuri KVM

Switch KVM magazine, preturi, oferte. Comparati preturile magazinelor online la Switchuri KVM gasiti cel mai mic pret, si cumparati cel mai ieftin Switch KVM din magazinul preferat.



Rackmount KVM

Provides instantaneous HD and 4K KVM matrix switching in mission-critical installations for reliable 24/7 operation. Control a remote computer from your local workstation while your critical hardware is

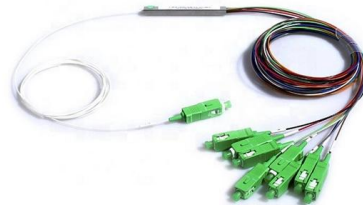

MAN_F1DC1XXH-8820-00768 dd

For a multi-unit configuration, the primary KVM switch (Rack-Mount Console) is always set to "BANK address 00". Each secondary unit must be set to a unique BANK address (from 01 through 15).





LC18 series User Manual-V2.5-202410

It is easy and fast to install the CAT5 KVM console; you just need to connect corresponding cables to the right ports of the CAT5 KVM and its module without software configuration.

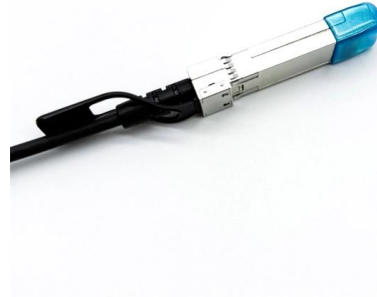

4/8/16 Port 1U Rack Mount VGA USB KVM Switch with OSD

Designed to ensure maximum space efficiency, the USB KVM switch features a slim 1U design that fits neatly into a server equipment rack/cabinet (with optional mounting bracket SV431RACK) and offers

Rackmount KVM Switches

Our rackmount KVM switches provide convenient, rack-mounted control options for single servers or switched options to control the entire server room, including



Cat5e/6/7 Rack-Mount USB KVM Switch Quick Start Guide V1.0 , FS

NOTE: The number of RJ45 to VGA Interface Module for KVM-08021P and KVM-080217IP is 8, and KVM-160217IP is 16. Rack-mount Kit is provided for KVM-080217IP and KVM-160217IP only.



KVM Switch Selector

KVM Switches Online A DirectNET Company For 30+ years, DirectNET companies have helped over 150,000 clients with their data center infrastructure and energy



How to Configure a NetCommander 1U Cat5 Rack-Mount KVM Switch

This 10-minute tutorial gives a detailed overview of the steps for configuring a 1U Cat5 rack-mount KVM switch for server racks.

KVM Selection Guide

The table below summarizes the types of KVM switches, from enterprise wide IP access to the extension of a single computer. Look at the Typical Applications column for the type that best matches your



Configure KVM Networking With virsh, nmcli and

brctl in Linux. Includes commands, verification, and troubleshooting.



Distribuitoare Switchuri KVM

La Conectica.ro gasesti o gama variata de distribuitoare switch KVM la preturi foarte bune. Comanda acum!

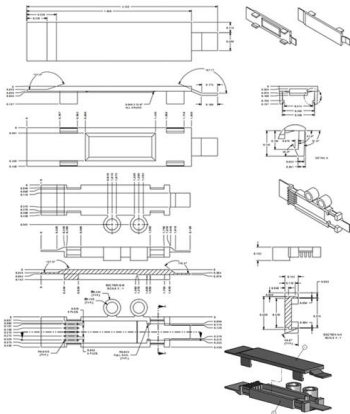

KVM SWITCH

KVM SWITCH - RACK MOUNT Quick Installation Guide DELL® READYRAILSTM RACK MOUNTING CONFIGURATIONS The ReadyRails system can be installed using the 1U tool-less method or one

KVM Over IP: 3 Essential Steps to Achieve Ultra-Low

Its intuitive control software and web GUI simplify configuration, ensuring efficient operations. A KVM over IP setup in a modern control room

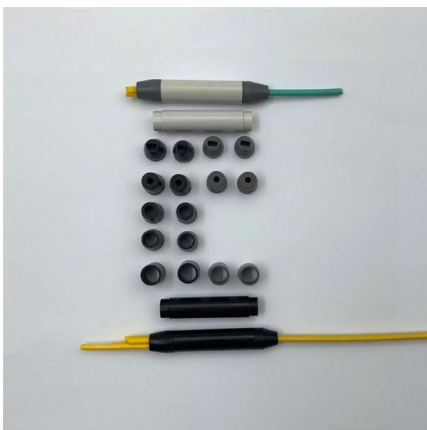

KVM Switch Frequently Asked Questions

The 19" Rack Console takes 1U of space, and is designed for use with 4-post racks. This Rack Console can be used with 2-post racks, although additional hardware is required.



KVM , Anixter Romania

APC KVM USB Cable - 25 ft (7.6 m) KVM cable
Black APC BY SCHNEIDER ELECTRIC MFR PART #
AP5261 PART # 443132 Minimum 1 Each View
All: KVM Sign In For Pricing Call for Availability
QTY

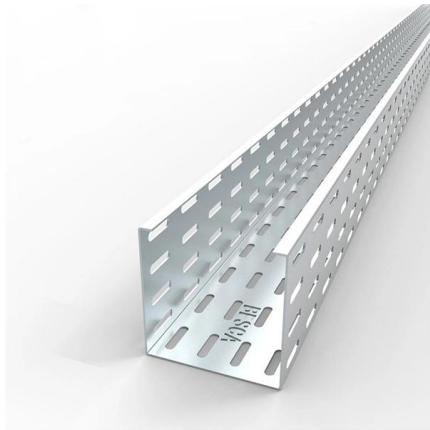
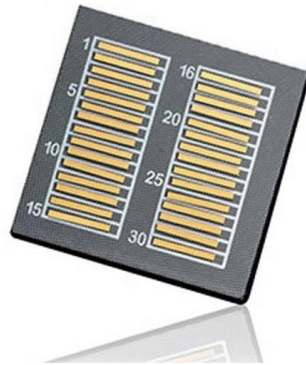

Distribuitoare si Switch-uri KVM

Bestsellers 1 Rack 19" 42U 800x1000 Stand
Alone cu usa fata metal perforat, Xcab
(dezasamblat, negru) 3.392 93 Lei 2 Rack 19"
22U 600x800 Stand Alone cu usa fata metal
perforat Xcab

Networking

Configuring Guest Networking Guest (VM)
networking in kvm is the same as in qemu, so it
is possible to refer to other documentation about
networking in qemu. This page will try to explain
how to configure



8 Port Rack Mount VGA USB KVM Switch with Audio

Introduction The SV831DUSBAU 8 Port Rack
Mount USB VGA KVM Switch (with Audio Cables
Included) allows you to control up to 8 USB
computers using a single keyboard, mouse and
monitor,

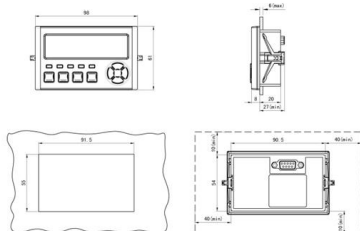



Einrichtung von KVM-Switchen , StarTech

It can be used both as a setup guide and a troubleshooting step. KVM RESET/SET UP PROCEDURE Start by ensuring everything is unplugged from the KVM,



KVM Switch Selector

Use the selector menu on the left to quickly narrow down and compare your KVM switch or rackmount monitor choices based on specific parameters you provide.



Rack Mount KVM Switches

Along with its 1U sized keyboard, video, and mouse setup, we customize our rack mount KVM switches to include a portable 1U keyboard drawer and other



The Complete Guide to KVM over IP , TinyPilot

The authoritative guide to KVM over IP -- how it works, how to secure it, and how to choose a reliable device for BIOS-level remote access.





Cauti kvm switch rack? Alege din oferta eMAG.ro

Ai cautat kvm switch rack. La eMAG, esti liber sa alegi din milioane de produse si branduri de top la preturi avantajoase ?.

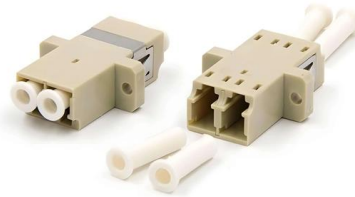

Cisco UCS Manager Administration Management Guide 3.1

KVM direct access allows the administrators that manage the blade and rack servers in your Cisco UCS Manager domain access the KVM for their servers directly using a web browser.

How to Set up Your New KVM Switch : Step by Step

Setting up a KVM (Keyboard, Video, Mouse) switch allows you to control multiple computers using a single set of peripherals. Here's a step-by-step



Contact Us

For datasheets, pricing, or custom high-speed optical interconnect solutions, please visit:
<https://www.syropy.com.pl>