

Provide a quotation for a distribution box





Provide a quotation for a distribution box



How much does septic distribution box replacement cost?

Septic distribution box (D-box) replacement costs \$600 to \$2,000 on average. Costs vary based on the materials used, local labor rates, and

What Is a Distribution Box?

What to Look for When Choosing a Distribution Box If you're going to buy a distribution box, there are several things you should look for. You should



Distribution Box Price, 2026 Distribution Box Price Manufacturers

Discover the perfect addition to your Power Distribution Cabinet & Box with our Distribution Box Price. Yes, factory custom power distribution cabinet & box services allow full OEM branding, tailored

Case Study-How to Customize a Distribution Box for

Customizing a distribution box is crucial for meeting project specifications, improving safety and functionality, and protecting against



Custom Power Distribution Box

Owning a factory and top-notch technologies, Sipolar always offers unmatched custom power distribution box to global customers. In recent years, our company leads the industry for advanced



XPO - LTL Freight Quotes and Logistics Services

XPO (NYSE: XPO) is one of the largest providers of asset-based less-than-truckload (LTL) freight transportation shipping in North America. Get LTL Freight Quotes



Distribution Box Solutions for Every Industry

Explore our diverse range of customized distribution boxes, widely used in different scenarios such as residential, commercial, and industrial.





The installation requirements for the distribution box

Learn how to install a distribution box safely and correctly. Covers wiring, placement, standards, and expert tips for a compliant setup.



Custom Power Distribution Box Manufacturers , J& HW

Custom Power Distribution Box Reliable Partner of Power Distribution Box with 15 Years of Experience Submit your requirements or design draft to us, and we'll

Top-Quality Fiber Optic Distribution Box Supplier

Secure and organize your fiber optic connections with our durable distribution boxes. With various sizes and configurations available, we offer reliable solutions to meet

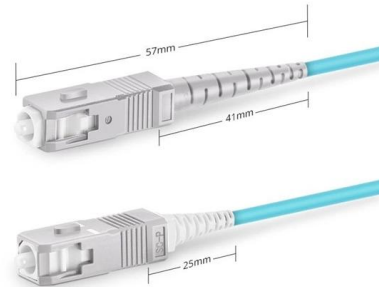

Simplex SC UPC

Explore Distribution Boxes for Every Setting with Different Types

Distribution boxes act as the central hub, receiving the main electrical supply and dividing it into designated circuits for lighting, outlets, and appliances. They provide a safe and organized way





The Complete Guide to Distribution Box: Installation, Types & More

The primary purpose of a distribution box is to provide a safe and organized way to control electrical circuits. When an electrical fault occurs, such as an overload or short circuit, the protective

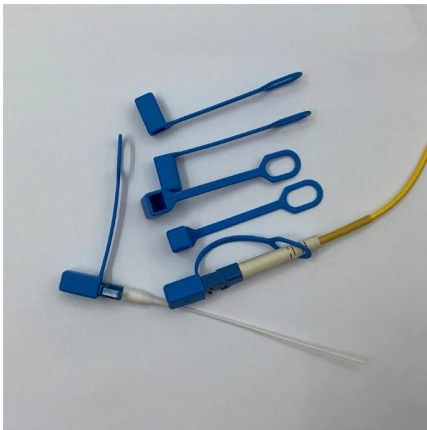
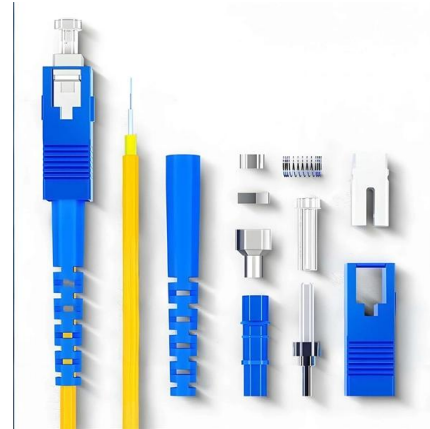

Understanding Distribution Boxes: A Comprehensive Guide

A distribution box, also known as a power distribution box or electrical distribution box, is used to distribute electrical power safely to multiple

What is a Distribution Box? - A Comprehensive Guide

A distribution box organizes and controls power flow, ensuring safety and efficiency in electrical systems.

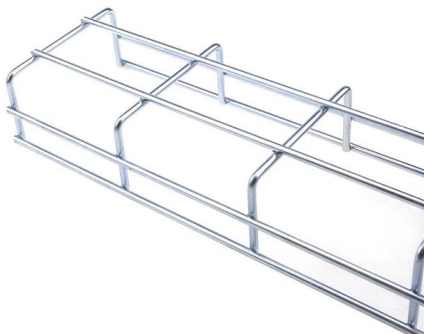

Where can I find custom quotations for distribution box manufacturers

Contact the distribution box manufacturer directly. You can contact them through their official website, customer service phone or email, ask them for engineering custom quotations, and provide relevant



DISTRIBUTION BOX

VIOX offers high-quality stainless steel distribution boxes in 201, 304, and 316 grades. From cost-effective indoor solutions to corrosion-resistant options for



15 Sample Letters of Request for Quotation

Subject: Request for Quotation - Office Supplies
Dear Supply Solutions Team, ABC Company requests a detailed quotation for the following office supplies to be delivered to our New

How to Install a Distribution Box--A Comprehensive

What is a Distribution Box? First of all, you need to have a simple understanding of the definition of a distribution box, and make it clear which kind

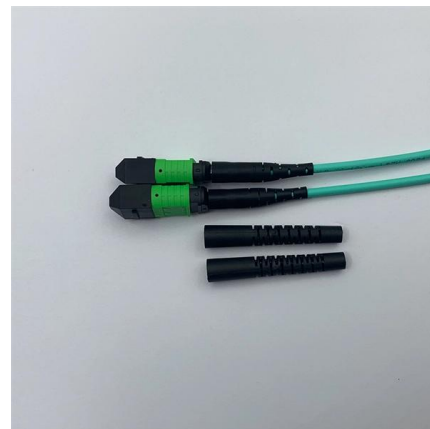

Distribution Box Manufacturer, Best Power Distribution

Distribution Box Manufacturer DOHO is a major manufacturer of distribution boxes and products in China. We have been providing quality OEM/ODM service to



Distribution enclosure, Distribution box

Find your distribution enclosure easily amongst the 112 products from the leading brands (RITTAL, BOPLA, ROSE,) on DirectIndustry, the industry specialist for your professional purchases.



Distribution Box Cost Guide 2024: Comprehensive Pricing, Features

Discover complete distribution box cost analysis including pricing factors, advanced features, safety benefits, and smart technology innovations. Get expert insights on ROI, installation costs, and long

What Is an Electrical Distribution Box? A Complete Guide

What Is an Electrical Distribution Box? An electrical distribution box serves as a centralized unit for distributing electrical power within various structures,

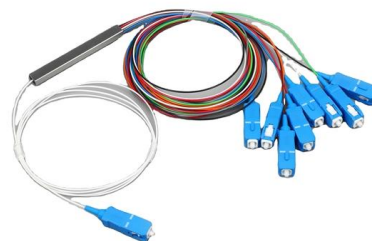

Wall Mount Cabinet Server Racks



Distribution Boxes Explained: Types, Functions, and

Learn about distribution boxes, their types, functions, and safety features to ensure efficient and secure electrical power distribution in any building.



Custom Power Distribution Box Manufacturers , J& HW

Discover reliable power distribution box manufacturers and custom power distribution solutions for every need.

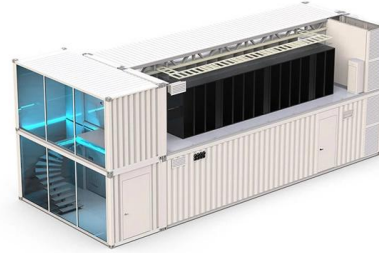

Power Distribution Box Price List , Request a Quote Today

Receive a Transparent Quote: We'll provide a detailed, no-obligation quote that includes all costs--no hidden fees, no surprises. Sit Back and Relax: Once you approve, we'll handle the

Contact Us

For datasheets, pricing, or custom high-speed optical interconnect solutions, please visit:
<https://www.syropy.com.pl>