

# **Price of high-voltage side busbar**

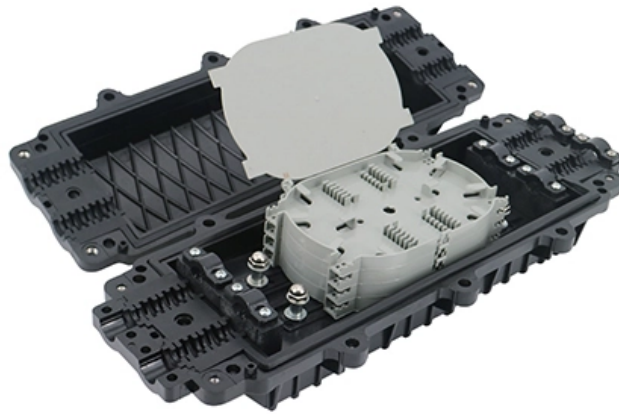



## Price of high-voltage side busbar

---

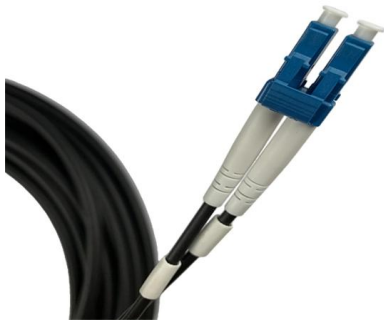

### Bus Bars , McMaster-Carr

Choose from our selection of bus bars, including over 650 products in a wide range of styles and sizes. Same and Next Day Delivery.



### High-Current High-Voltage Solutions

Molex provides a versatile range of high-current high-voltage busbar solutions suitable for various applications and environments. Busbars and busbar

### Catalog Extract LV 10 · 04/2023

Take advantage of the benefits of digitalization at every step of the project with the SIVACON 8PS busbar trunking systems - from planning to installation on up to operation.



### HV Power Connectors , Tubular Busbar , Alcomet

Through our partnership we're able to offer a complete range of copper and aluminium high voltage power connectors. We are also able to offer Copper and



### High voltage bus bar

For more than 12 years, Exxelia SVM has also specialized in the design and production of busbars with a variety of technologies and finishes, including: These



### 2CDC446001D0201

Busbar systems and installation accessories  
When connecting aluminum conductors, ensure that the contact surfaces of the conductors are cleaned, brushed and treated with grease.



### Types of Busbars & Schemes - Explained with Applications

Busbars improve current efficiency, reduce voltage drops, save space, and simplify installation. They also allow easy expansion, better thermal





## High Voltage Busbars

To connect various high voltage (HV) components to the HV system, we also deliver a wide variety of busbars. In cooperation with the customer, these can also feature our Bus Bar Insulation Tubing (BBIT).



## Insulated Busbars for Electrical Distribution

Explore insulated busbars designed for safer power distribution, compact installation, and reliable performance in electrical systems.

## Electrical Panel Design: Busbar Size Calculation Chart

Because the high voltage line has less current and the busbar is selected based on busbar current. Measuring HT side busbar size and weight is as same as LT side.

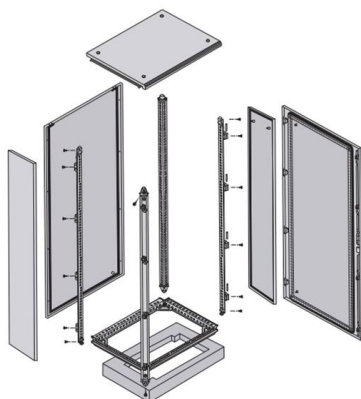
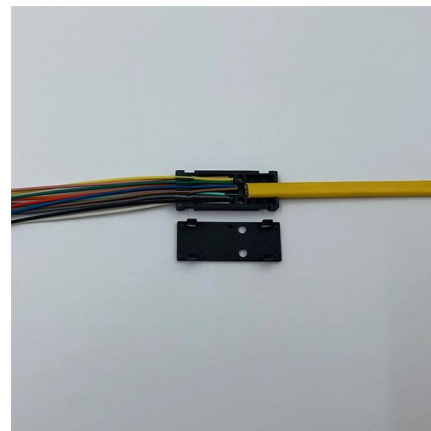

## Catalog LV70 - 2019

Modern infrastructure, such as hospitals, office buildings and airports, must meet stringent requirements in terms of safety, low environmental impact, and integration of renewable energy. Our low- and

## Bus Bars , Ground Bus Bar Connectors,



## Electrical Bus

Bus Bars Where electric power distribution is needed, you'll find busbars. Whether you're searching for aluminum busbars, copper busbars or insulated busbars,



### More products



## Catalog LV 10 10/2017, chapter 17

The busbar trunking system for power distribution in the skilled trades and business: High degree of protection up to IP55 Flexible power supply Easy and quick planning Time-saving mounting Reliable

## Low-voltage (LV) and high-voltage (HV) busbar ducts

KiloAmps® offers a complete collection of busbars ducts specially designed to meet all your electrical distribution needs.



## HV Busbars

Our HV Busbars provide a reliable solution for compact high-voltage power distribution. With high conductivity and a robust design, they deliver maximum performance in minimal space - efficient,



## High Voltage Busbars by Intercable Automotive Solutions

One of the signature products developed by Intercable Automotive Solutions are our custom made high-voltage busbars manufactured to client specifications. Busbars

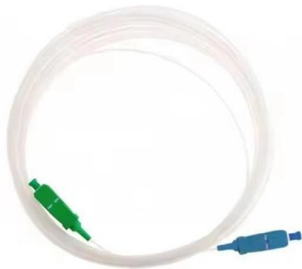

## High Power Converter Busbar in the New Era of Wide

The busbar is crucial in high-power converters to interconnect high-current and high-voltage subcomponents. This paper reviews the state-of-the-art

## Catalog Extract LV 10 · 10/2022

Our busbar systems for electrical installations offer a particularly easy way of fitting distribution systems with electrotechnical components. The modular design saves space, while quick assembly contacts

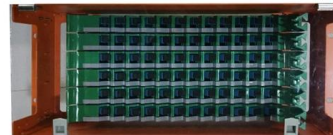

## Vertiv(TM) PowerBar HPB

Vertiv(TM) PowerBar HPB is a 1000V totally encased, non-ventilated and low impedance busbar. HPB sandwich construction range has been engineered for



## Busbars , Electrical Busbars & Copper Busbars , RS

Here, at RS we have a comprehensive range of Busbars supplied to you from industry-leading brands including Schneider Electric, Siemens, ABB, Eaton, and Legrand. As mentioned before busbars are



## Busbars for High-Voltage Power Systems: The Key to

Busbars are indispensable components of high-voltage power systems, ensuring efficient and safe power transmission. Selecting and utilizing

## Tubular Busbar , Copper Or Aluminium , 33kV, 66kV

We offer Copper and Aluminium Tubular Busbars in a range of sizes to suit 33kV, 66kV and 132kV substations. Contact us for more information.



## High-voltage busbar

Find your high-voltage busbar easily amongst the 6 products from the leading brands (LEONI, TELEDYNE, HLC, ) on DirectIndustry, the industry specialist for your



## Bus Bar Price

They incorporate features like varied current and voltage ratings, high-quality materials, insulation properties, lightweight designs, and efficient cooling mechanisms. These BusBar Chambers are



## The Ultimate Guide to Electrical Busbars [May 2026 ]

In high-voltage switchyards and low-voltage battery banks, busbars are the go-to solution for managing incoming and outgoing power efficiently. Their

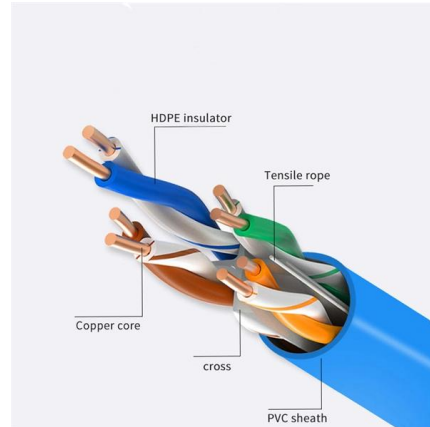

## Busbar Products Pricing Guide: Understanding Costs

This guide offers a detailed busbar pricing guide for electrical contractors, explores what affects pricing, and provides strategies to get the best value busbar



## Busbar Design for High-Power SiC Converters

Busbars are critical components that connect high-current and high-voltage subcomponents in high-power converters. This paper reviews the latest



## High Power Multi-layer Molded Busbars: Design

High Power Multi-layer Molded Busbars: Design Considerations and Construction Options  
Minimizing efficiency loss is key to success for next-generation EV-Mobility Overview The accelerating adoption



## Contact Us

---

For datasheets, pricing, or custom high-speed optical interconnect solutions, please visit:  
<https://www.syropy.com.pl>