

# **Price of Grounding Relay Protector**

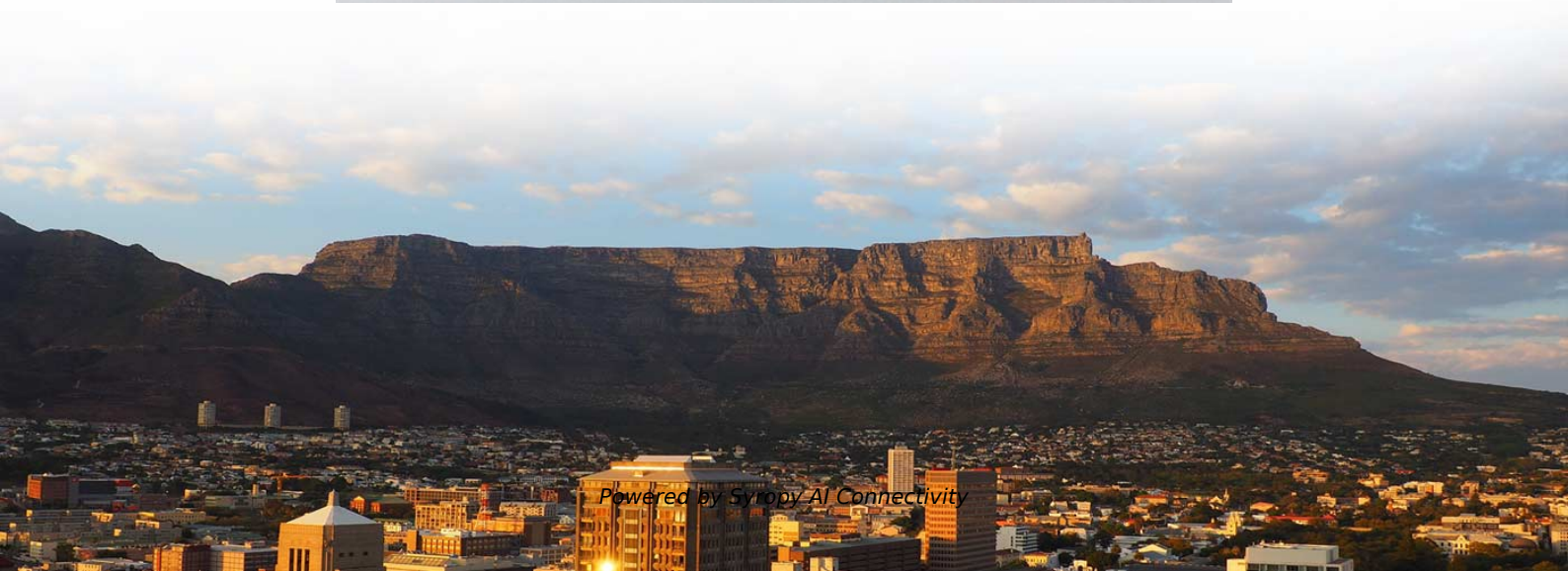



## Price of Grounding Relay Protector

---



### Schneider GFP13 Ground Fault Protector 0.5-3 Sec Relay FREE

Spread the cost of your purchases over 3 to 24 months with an interest rate from 0.00-35.99%. There's no fees if you pay on time.

### Dreyoo Neutral Ground Bonding Plug for Portable

About this item For Open Ground Error: portable generators with a floating neutral or surge protector can be detected open ground fault, it not power up the RV when

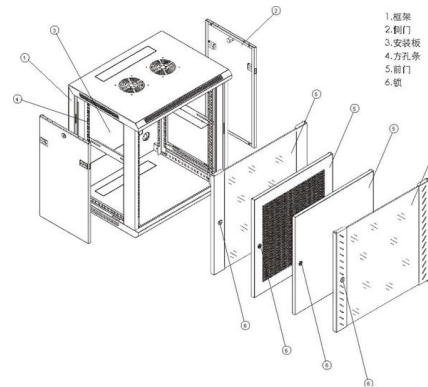

### Neutral Grounding Resistors (NGR) Explained: What

Neutral Grounding Resistors (NGR): how they work, where they're used, key benefits, and why they're critical for fault current protection.



### Ground Fault Protection Relay Panel 2026

Find top-rated ground fault protection relay panels with adjustable trip settings, 480V rating, and remote monitoring. Compare verified suppliers, MOQs, and pricing.



### **Crompton Instruments Protector Trip Relays**

Protector Trip Relays An extensive range of electronic control products providing continuous monitoring and protection of any electrical parameter. When the monitored parameter deviates from the desired



### **Ground Fault Relays for Grounded & Ungrounded Systems**

Browse a selection of Littelfuse ground fault relays, which are essential for protecting systems from ground faults.



### **Ground Fault Protection Specification Guide , PDF**

The document discusses ground fault protection devices from manufacturer IPC Resistors Inc. It provides detailed specifications for 9 different ground fault



**SPDTableOfContents.qxd**



Ground fault relay schemes and shunt trip mechanisms on switches or circuit breakers can protect equipment against extensive damage from low magnitude ground faults - this is their intended purpose.

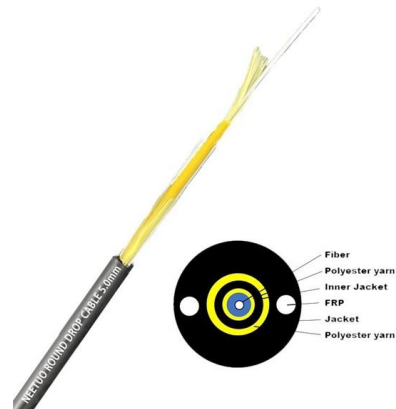

### Earth Fault Relay at Best Price from Manufacturers

Find Earth Fault Relay manufacturers, suppliers, dealers & latest prices from top companies in India. Buy from a wide range of Earth Fault Relay online.

### Protective relays for mains protection , Phoenix Contact

Our protection technology at a glance Protect, monitor, and control electrical grids Intuitive device operation The front panels of the protective relays offer numerous

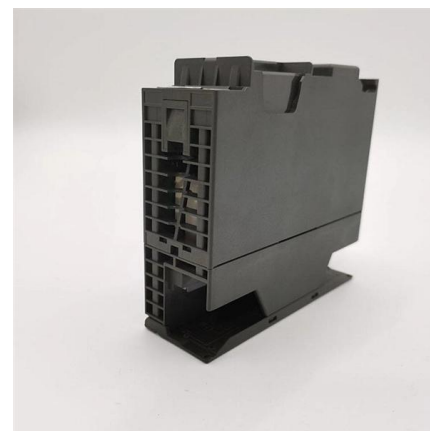

### Home

P& B is a leading UK innovator of electrical protection, safety and control technologies. Our specialist expertise and unrivalled experience is relied upon in heavy industries throughout the



### **Generator Rotor Earth Fault Protection Relay**

Product Introduction : The GWZC-9682 Generator Rotor Earth Fault Protection Relay is designed to detect and protect against ground faults in generator rotor

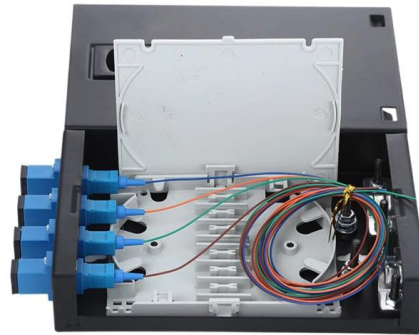

### **BE1-64F, Ground Fault Relay , Basler Electric**

This device is designed to detect unintentional grounding in the field winding of a synchronous generator or motor. Models are available for

### **High Resistance Grounding**

5kV Class High Resistance Grounding Assemblies Available in a stand-alone cubicle or mounted integral to your 5kV switchgear line-up, Powell's Ground-Gard high



### **Low Resistance Grounding**

Low resistance grounding resistor systems protect power transformers and generators from damaging fault currents. Low resistance



## High Resistance Grounding

The Powell Ground Protect Plus(TM) can be purchased as a complete free-standing unit, wall mount or incorporated as an integral part of your low voltage switchgear



## Ground Fault Protection

Ensure safety with NK Technologies' ground fault relays. Detect and prevent faults in industrial and commercial settings. Learn more Today!

## Acrel 300286. Sz Factory Asj10-Ld1a Variable Earth

Acrel 300286. Sz Factory Asj10-Ld1a Variable Earth Leakage Protection Relay Ground Fault AC Monitoring Relay, Find Details and Price about

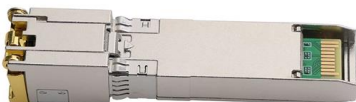

## MORA 63A OVER AND UNDER VOLTAGE AND

A surge protector like this one manufactured by the reputable brand Mora is an appliance or device designed to protect electrical devices from voltage and



## Ground Fault Monitoring Relays

Buy Ground Fault Monitoring Relays. Newark Electronics offers fast quotes, same day dispatch, fast delivery, wide inventory, datasheets & technical support.



### Static Charge Grounding Relay , Reliable Protection

Protect against static electricity with advanced grounding relays. Explore reliable static charge grounding systems for industrial safety and efficiency.



### 64F ground detection relay

The Type 64F machine ground detector relay detects grounds in normally ungrounded circuits, such as a machine field winding. These ground faults should be detected and removed immediately, since a

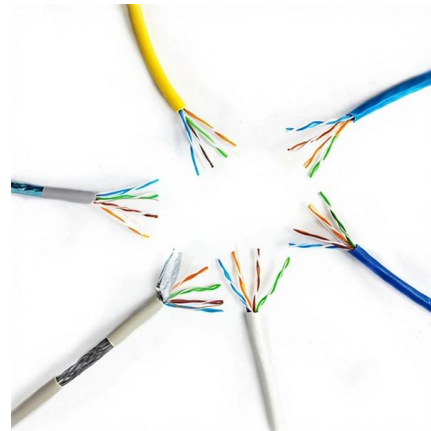

### SEL-2664S Stator Ground Protection Relay , Schweitzer

Protect high-impedance grounded generators from ground faults at standstill, during startup, and while running by using the multisine frequency injection and neutral





## Crompton 256-PRBU-R2BX-DG-RO-LI-RB Protector

Description 0 Reviews Crompton 256-PRBU-R2BX-DG-RO-LI-RB Protector Trip Relay - Hot Spot Relay 256 Protector Trip Relay - Hot Spot Relay 1 TRIP



## Ground Fault Protection Relay , Products & Suppliers

Find Ground Fault Protection Relay related suppliers, manufacturers, products and specifications on GlobalSpec - a trusted source of Ground Fault Protection Relay information.

## Ground Fault Monitoring Relays

17 Products Found Newark offers ground fault monitoring relays designed to detect and isolate leakage currents, enhancing safety and preventing electrical hazards. Available in multiple configurations,



## Contact Us

---

For datasheets, pricing, or custom high-speed optical interconnect solutions, please visit:  
<https://www.syropy.com.pl>