

Portuguese Industrial Switch Parameter Settings





Portuguese Industrial Switch Parameter Settings

00000000



Configuration manual for industrial switch

The industrial switch configuration manual is a detailed guide that instructs users on how to correctly install, configure, and optimize industrial-grade switch equipment.

WinCC Unified

The parameter set display in WinCC Unified enables the configuration of plant and process parameters. You can configure different sets of parameters,



Danfoss Inverter Parameter Settings Guide

The document provides instructions for setting parameters on a Danfoss inverter for various compressor models. It includes steps to copy settings from a pre



Profinet slides

These settings are transferred to the SIMATIC CPU and from there to the PROFINET devices. The CPU defines IP addresses and PN names according to the topology made in the TIA Portal. Also for

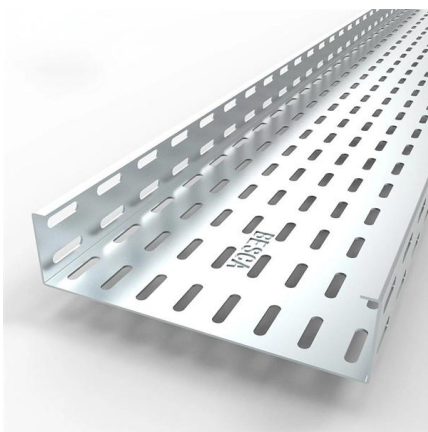
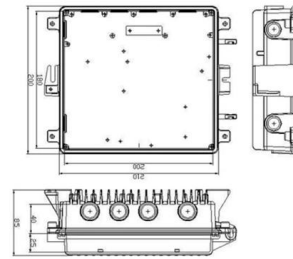

Professional guide for selecting Industrial Ethernet Switch ports

September 26, 2024 Professional guide for selecting Industrial Ethernet Switch ports In the deployment of IIoT, Industrial Ethernet Switch is the core component of the network, and its port settings directly

Parameter Manual, Machine data and interface signals

The Parameter Manual provides information on parameters and their effects on the system. The Parameter Manual enables the intended target group to evaluate fault displays and to respond



Reason S20 Industrial Managed Ethernet Switch

Switch Ethernet Gerenciável Industrial A gama de switches Ethernet gerenciáveis Reason S20 da GE foi projetada industriais tais como sistemas elétricos de potência, fornecendo todos os elementos em



Industrial Switches for Modern Manufacturing and

Discover how industrial switches support modern manufacturing and automation with durability, flexibility, quality of service, and robust cybersecurity.



SSW-05_V2.3X_9_0899.5119 ok.pmd

Installation and Operation Manual - SSW-05 Plus
Version 2.3X - 0899.5119 /9

Reason S20 Industrial Managed Ethernet Switch

Existem várias maneiras de separar o tráfego prioritário dos tráfegos de uso geral, o Reason S20 aceita a função QoS nos bits de Classe de Serviço (CoS) e DSCP, para comunicação nas camadas 2 e 3,

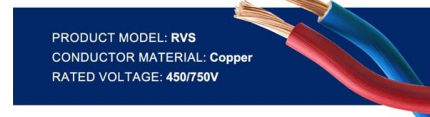
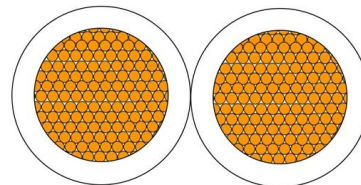

Support

To enable logging for different submodules or events at different levels, configure this feature multiple times by specifying different parameters. The log levels are error-fatal, error, high-warning, warning,



Industrial Switches , Industrial Ethernet Switches , Antaira

Since 2005, we have designed and manufactured top-quality industrial switches with network redundancy that operate efficiently in rugged, mission-critical applications. Setup a reliable Ethernet



How do you enter the parameter setting mode?

The parameter-write-enable (pwe) switch This switch allows you to enter the parameter setting mode. With older controls like the 3, 5, and 6 series



What Are The Common Pressure Switch Settings?

Understanding the common pressure switch settings is essential for maintaining the optimal performance of various industrial and commercial equipment.



parameters setting

Many translated example sentences containing "parameters setting" - Portuguese-English dictionary and search engine for Portuguese translations.



Instantiation and configuration of safety modules /

However, change of safety I/O parameters using generic device configuration view is not recommended due to potential user mistakes during the parameter setting



List manual G120C

For parameters where the unit can be switched over, the specifications for "Unit group" and "Unit selection" determine the group to which the parameter belongs and with which parameter the unit

Parameter Manual, Parameter description

Setting this parameter filters out the parameters that can be written into in the various commissioning steps. For the BOP, this setting also causes the read access operations to be filtered.

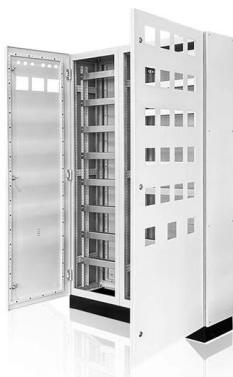
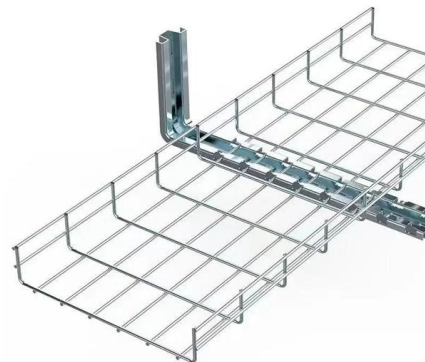

Industrial Switches , Types, Applications, and Benefits in Automation

Learn about industrial switches, their key types, uses, and benefits in automation, from enhancing control to boosting efficiency and safety in industrial systems.



Stratix 2000 Ethernet Unmanaged Switches User Manual

Stratix 2000 switches use two methods to determine the threshold for incoming broadcast traffic, depending on the switch catalog number:
Packet-based threshold--The switch counts the number of

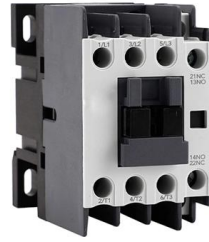

How to Select, Configure, and Apply Industrial Switches for the

Configuring an industrial switch involves setting up the necessary network parameters and enabling desired features. Here are some general steps to follow: Basic Settings: Start by assigning

2080-QS002B-EN-E Micro800 Programmable Controllers: Getting Started

Micro800 Programmable Controllers: Getting Started with CIP Client Messaging Catalog Numbers Bulletin 2080-LC20, 2080-LC30, 2080-LC50



FX3S/FX3G/FX3GC/FX3U/FX3UC SERIES PROGRAMMABLE

Series Programming Manual - Basic & Applied Instruction Edition (this manual) JY997D16601 Items related to programming in PLCs including explanation of basic instructions, applied instructions and





switch parameter in Portuguese

Check 'switch parameter' translations into Portuguese. Look through examples of switch parameter translation in sentences, listen to pronunciation and learn grammar.



automatic setting

Many translated example sentences containing "automatic setting" - Portuguese-English dictionary and search engine for Portuguese translations.

Comprehensive Guide to Communication Parameter

Comprehensive Guide to Communication Parameter Settings of Yaskawa V1000 Inverter
---- Accessing and Configuring H5-01 and H5-02



Setting Up an Industrial Network Switch for Beginner

Are you new to setting up industrial network switches and feeling overwhelmed? Don't worry, we've got you covered! In this comprehensive tutorial, we'll walk



Configuration manual for industrial switch

December 6, 2024 Configuration manual for industrial switch In the IIoT and a wide range of industrial applications, industrial switches serve as the core devices for network connectivity. The correctness



Setting and storing safety-related parameters during commissioning or

The measures described in this document for controlling the effects of errors caused by the parameter transfer process end with the release of a parameter checked for data corruption.

Low Voltage Isolation Switch Factories & Suppliers in Portugal

Suppliers in Portugal are no longer just providing "hardware"; they are providing safety guarantees for the Portuguese National Grid (Redes Energéticas Nacionais - REN) and local distribution networks.



Contact Us

For datasheets, pricing, or custom high-speed optical interconnect solutions, please visit:
<https://www.syropy.com.pl>