

North African bundled tail fiber

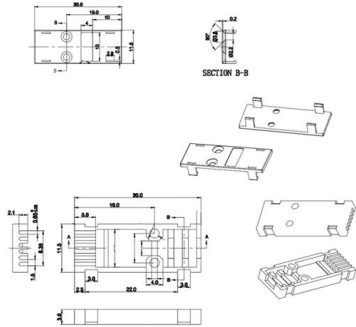



North African bundled tail fiber



Spec Sheet

Regional Availability -- Global Siemon's Bundled Fiber Trunks offer a streamlined and efficient solution for your fiber optic network needs. By bundling high-performance fiber cables together, we've

THE FUTURE OF AFRICAN FIBER

Xalam's Future of African Fiber report series explores all these questions and more. It is the outcome of a long, arduous and ambitious effort - an attempt to provide an in-depth view into key trends,



NiaFiber

About Us We Are Trusted Fiber Manufacturing Company Our technological heritage includes the first to market offerings for many of the fiber optic products that meet

Fibre chapter7

Terrestrial transmission network is bringing additional countries, regions, cities and towns within reach of fibre networks for the Africa's total inventory of operational fibre optic first time. In the last ten years,



Tail Fiber: Types, Functions, and Common Interfaces

A tail fiber, also known as a fiber optic patch cord, consists of a connector on one end and a cut end of the fiber optic cable core on the other. These patch cords are primarily used to



Fiber tail fiber characteristics

The bundled pigtail has only one end with a connector, and the other end is a broken end of an optical fiber, which is connected to other optical fiber



List of terrestrial fibre optic cable projects in Africa

The construction of both submarine cables and their terrestrial extensions is thus considered an important step to economic growth and development to many African countries.



What is Fiber Pigtail? A Complete Guide for Beginners

A fiber pigtail is a fiber optic cable with pre-terminated fiber connector and exposed fiber. This guide introduces fiber pigtail basics, types.



Fiber optic pigtails: A comprehensive guide and overview

- Fiber optic pigtails have a pre-terminated connector and bare fibers on the other end, while patch cords have pre-terminated connectors on both ends. - Fiber optic pigtails are typically

Fibre chapter7

Developments in subsea fibre mega-systems. Two new 140+Tbps subsea cable systems are currently in deployment around Africa's coast, bringing a huge boost to Africa's subsea capa



chapter Fibre

Once the fibre network which is currently under construction enters service, the fibre reach of sub-Saharan Africa will increase to 62.0% (726 million), and once the network which is planned or

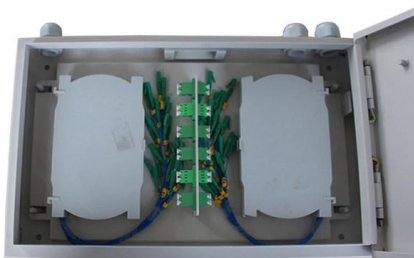



Phage tail fibre assembly proteins employ a modular structure to drive

The crystal structure of a complex between the tail fibre and tail fibre assembly (Tfa) protein of Escherichia coli phage Mu reveals the mechanisms by which Tfa regulates fibre assembly



Pre-terminated / connectorized fiber optic cable assemblies by AFL.

Pre-terminated Cable Assemblies - AFL fiber optic cable assemblies include connectorized, pigtails, jumpers, simplex, duplex, high fiber count, node cables and MPO assemblies.

Product characteristics of bundle tail fiber

The bundle tail fiber is composed of Corning tight sleeved optical fiber conforming to the full spectrum specification, wrapped with aramid fiber



BUNDLED MICRO DUCT

2, 4 and 7 x 8/5mm BUNDLED MICRO DUCT
Bundled-micro duct, smooth Silicon lined, High Density PE Outer Sheath





National Center for Biotechnology Information

Hier sollte eine Beschreibung angezeigt werden, diese Seite lässt dies jedoch nicht zu.



Equipped with a removable **Mounting Plate** inside the enclosure, enabling customized drilling and secure component mounting.

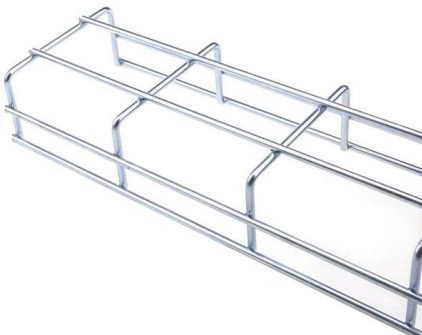

Preterminated Bundle Fiber Optic Cable Assemblies

Preterminated Bundle Fiber Optic Cable Assemblies are manufactured from 2 to 288core fibers terminated with various connector for easy installation.

Fiber Brings Faster Fixed Broadband to North Africa with

Fiber internet rollout is reshaping fixed broadband in North Africa. Dive into the latest performance data from across the region.

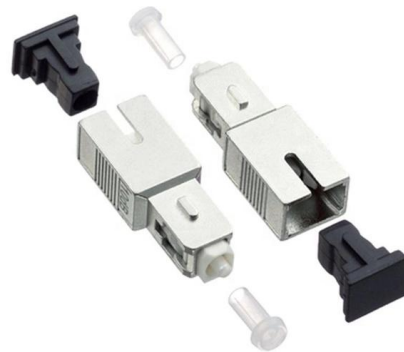

Fiber-optic leap bridges African digital divide

Though tech giants have invested heavily in high-performance digital infrastructure -- more cell towers, faster networks -- Africans across the

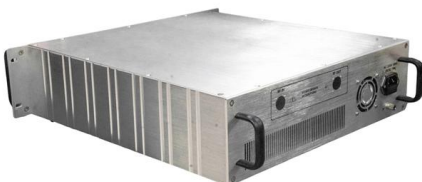



Bundle tail fiber Failure analysis

Bundle tail fibers, also known as ribbon fibers, are multiple fibers that are aligned and bonded together in a ribbon-like shape. The bundle tail fiber is a

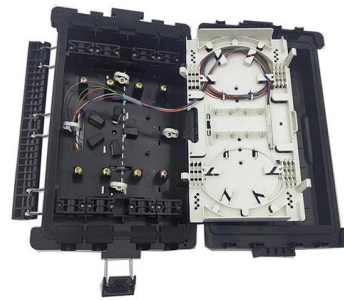

Fiber tail fiber

Fiber optic cables are a type of transmission medium used to transmit data over long distances at high speeds. They are made up of thin strands of glass or plastic fibers that are used to

What is a Fiber Optic Pigtail, and What Is It Used For?

A fiber optic pigtail is a type of fiber optic cable with only one end that has a factory-terminated connector and the other end exposed as bare fiber. A



Africa's Optical Fiber, Bundles, and Cable Market Set to

Africa's journey toward digital transformation is gaining momentum, and at the core of this progress lies the expansion of optical fiber, bundles, and

To be the leading end to end manufacturer and consultant for Fiber infrastructure solutions and accessories in Africa.



Zimbabwe's rail fiber optic project kicks off

Dark Fiber Africa (DFA) and Bandwidth and Cloud Services Group (BCS) have completed the first stage of their long-haul fiber backbone project

The Future of African Fibre Markets

Xalam's reference report on African fiber markets, from the first mile to the last mile. Including international capacity demand and supply forecasts, wholesale fiber

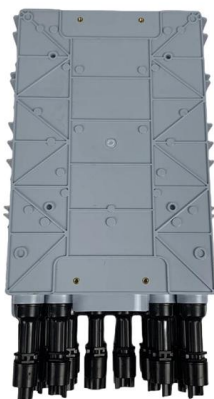

Fixed Internet Speeds are Improving in North Africa, and

Fixed Internet Speeds are Improving in North Africa, and Fiber Could Boost Them Even Further Since 2020, fixed broadband speeds in North Africa



The Future of African Fibre Markets

Today, fiber networks are an essential enabler of what we have called Africa's age of cloud; they are the glue that binds together the African Internet. The African fiber



Contact Us

For datasheets, pricing, or custom high-speed optical interconnect solutions, please visit:
<https://www.syropy.com.pl>