

# **Niger RoHS compliant active optical equipment NRZ**

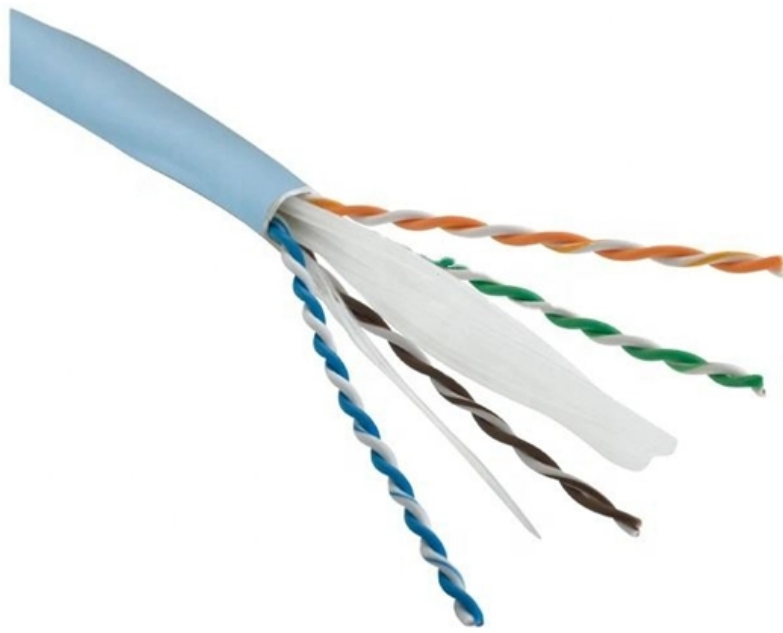



## Niger RoHS compliant active optical equipment NRZ

---

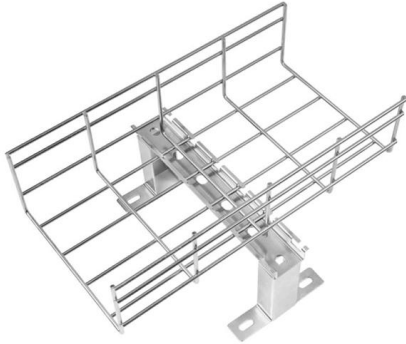

### 100G QSFP28 Active Optical Cables 4x25G NRZ, 100Meters (328ft)

FIBERSTAMP 100G QSFP28 AOC active optical cable is used for short-distance interconnection between internal devices in data centers. It complies with IEEE 802.3bm 100GBASE-SR4 Ethernet

### Quality & Compliance , ISO, ITAR, RoHS, NIST Optics, Assemblies

Optics and assemblies that meet ISO 9001:2015, ITAR, and quality, safety, performance, and security requirements. RoHS certification available.



### RoHS Directive Explained: Compliance for Electronics and

Navigate RoHS compliance for electronics. Understand restricted substances, global reach, and how due diligence ensures safety, market access & sustainable supply chains.

### RoHS Product Lab Testing: A Complete Guide

An essential guide to RoHS lab testing requirements, cost examples, cost-saving strategies, common mistakes, and more.

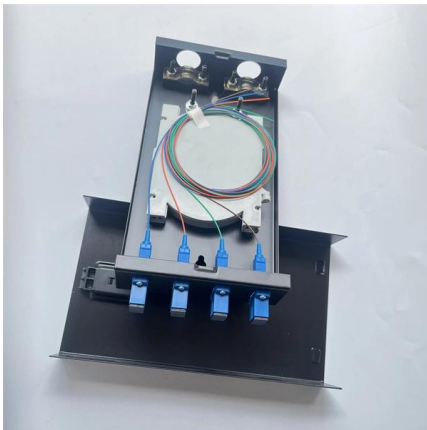

### RoHS and REACH Compliance

UQG Optics hereby affirms its compliance with the RoHS Directive and undertakes that none of the optical products and components that it manufactures contain any significant levels of substances

### What is RoHS Compliance? Understanding the

What RoHS certification means, which substances are restricted, and why compliance matters for electronic manufacturers and importers.



### Restriction of Hazardous Substances Directive (RoHS)

Understanding and complying with RoHS The Restriction of Hazardous Substances (RoHS) is a set of regulations that limit the use of hazardous substances such as



## RoHS Certification in Niger , RoHS compliance experts

In this detailed guide, we'll go through & understand how to get RoHS certification in Niger & other major cities Niamey, Zinder, Maradi, Tahoua, Agadez, Dosso, Diffa, Tillabéri, the meaning of RoHS, its

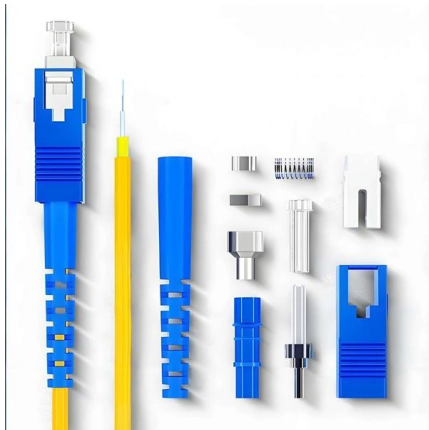

### Optoelectronic Devices 850 nm 28 Gbps NRZ Multimode VCSEL

RoHS and REACH Compliance We are fully committed to environment protection, human health and sustainable development and have set in place a comprehensive program for removing polluting and

### Understanding RoHS (Restriction of Hazardous

What does RoHS mean? RoHS is an acronym for "Restriction of Hazardous Substances." It is a directive in the European Union that regulates the



### Compliance and regulatory standards for our products - ATGBICS

ATGBICS by Approved Technology, a leading brand in optical network connectivity, fully compliant with RoHS, CE, EMC, REACH, and FCC standards for environmental and safety.





### Optoelectronic Devices 850 nm 28 Gbps NRZ Multimode VCSEL

RoHS and REACH Compliance polluting and hazardous substances from all our products. The relevant evidence of RoHS and REACH compliance is held as part of our co 2024 Coherent Corp.



### MFA1A00-E005 Mellanox MFA1A00-E005 Active Optical Cable

Attributes Optical Fibers, Active Optical CableType LCConnector Type InfiniBand EDRUse Wired LAN, 4 GNetwork MFA1A00-E005Model Number MellanoxBrand Name Place of Origin:Mae Hong Son,

### RoHS Directive Compliance for Medical Devices , TÜV

Under EU Directive 2011/65/EU (RoHS II), medical devices will be subject to restrictions regarding the use of hazardous substances as of 22 July 2014, and in



### Review of the RoHS Directive

Executive Summary Medical technologies include more than 500,000 types of medical devices and in vitro diagnostic medical devices that aim to improve, extend, and transform people's



## Synopsis of Questions to be Answered 20

RFID which are attached permanently to (or are difficult to separate from) appliances/equipment falling into other Categories of RoHS, may be considered a component part of such appliances/equipment



## RoHS Compliance: A Comprehensive Guide , BradyID

RoHS compliance is crucial as it targets the reduction of hazardous substances in electrical and electronic equipment (EEE), fundamentally designed to protect the

## ROHS Certification in Niger, Consultants in Niamey, Zinder, Maradi

ROHS Consultants in Niger led by experienced trainers for providing ROHS certification in Niger, Niamey, Zinder, Maradi, Agadez, Alaghsas, Tahoua and other major cities in Niger.



## Optics Manufacturer & Supplier , Imaging Lens & Laser Optics

Edmund Optics has been a leading producer of optics, imaging, and laser optics for 80 years. Discover the latest optical and imaging technology.



## RoHS Guide

These materials may not be restricted under RoHS, but they carry major compliance, worker-safety, and environmental responsibilities. RoHSGuide connects these layers into a single framework of product,

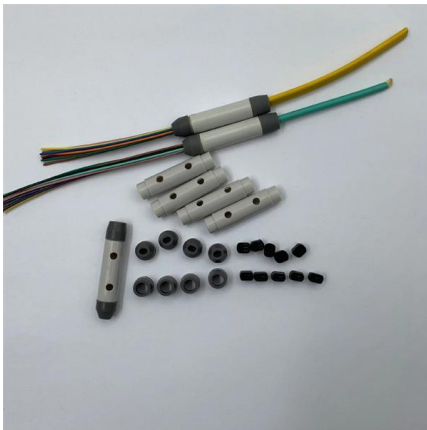

### RoHS Certification in Niger , Top 10 RoHS Consultants in Niger

One such standard is the Restriction of Hazardous Substances (RoHS) directive. In this comprehensive article, we will delve into the world of RoHS Certification in Niger, exploring its importance, the

### RoHS Compliance: A Comprehensive Guide

Learn everything about RoHS Compliance in this comprehensive guide. Discover what RoHS Compliance is, why it's important, the specifics of the RoHS directive,

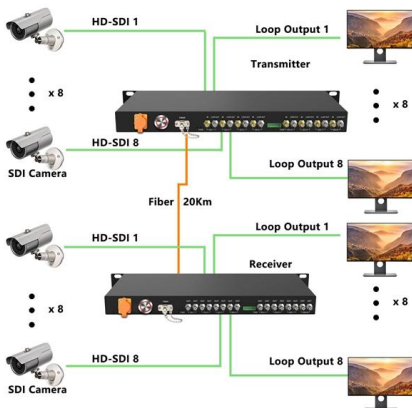

### Compliance FAQs: RoHS , NIST

China RoHS 2 was based on the European Union's Restriction of Hazardous Substances in Electrical and Electronic Equipment (RoHS) 2 directive. What types of products does China ROHS



### Optical glass and the EU directive RoHS

Optical glass is part of optical systems, being subject to the EU directive RoHS, restricting the use of certain hazardous substances in electric and electronic equipment. Some special optical

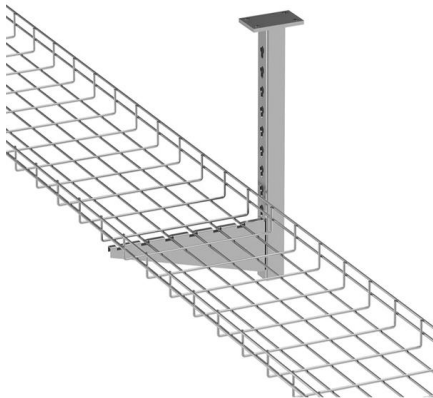
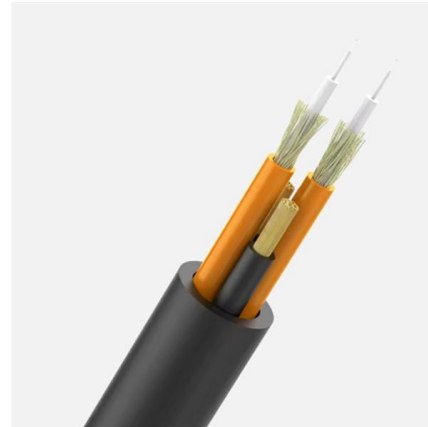

### EU Restriction of Hazardous Substances Directive

A practical guide to the RoHS directive, including covered products, limits, required documents, CE marking, and components.

### rohs certificate Companies and Suppliers serving Niger ,

Advanced Technical Services GmbH has over 40 years experience in the fields of photonics and opto-electronics, with particular emphasis on optical emission spectroscopy and optical fluorescence

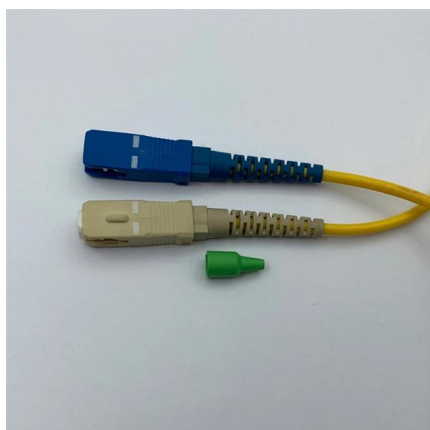

### ARCEP Niger Type Approval: New Compliance Rules for Telecom Equipment

ARCEP Niger type approval introduces new telecom equipment compliance rules, including lab testing, labeling, and local representation requirements effective immediately.



## Niger Type Approval: Last Updates 2025

ARCEP Niger issued a new type approval regulation on the content and conditions for issuing the type approval certificate for radio and electronic equipment.



## Contact Us

---

For datasheets, pricing, or custom high-speed optical interconnect solutions, please visit:  
<https://www.syropy.com.pl>