

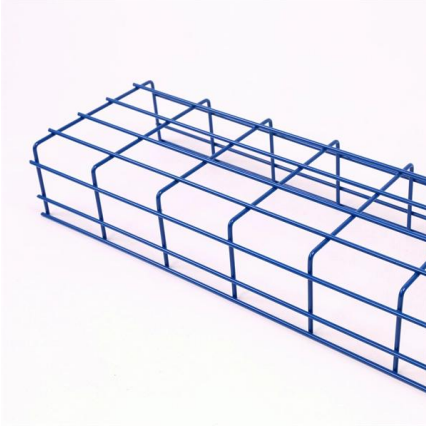



## Myanmar Fiber Optic Cable Trenching Machine

---



### Fiber optics installation with Microtrenching technology

Microtrenching is an installation method where a microtrenching machine (like the Vermeer micro trencher RTX550) is used to install fiber optics cable or conduit by

### MDEG , Myanmar Development Engineering Group Co.,

As technology improves, more and more companies and organizations are getting fiber optic cables. Not only will you save money over copper wires, but they're

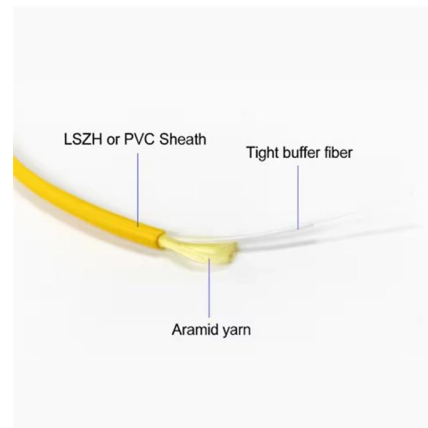

### Clean & Fast solutions for FTTx

Clean & Fast solutions for FTTx The increasing use of fiber optics and new generation networks such as 5G in the telecom sector has boosted the

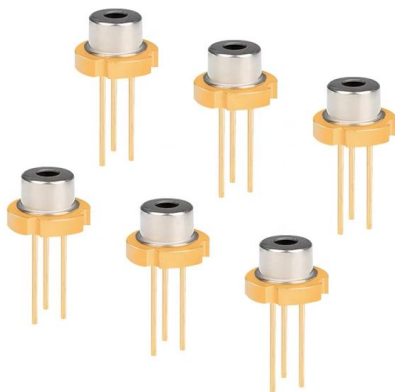

### Road Trenching Cable Fiber Optic Ditch Digger

The trenching machine can work continuously, the construction efficiency is high, and the surface damage is small. It is especially suitable for laying pipelines and

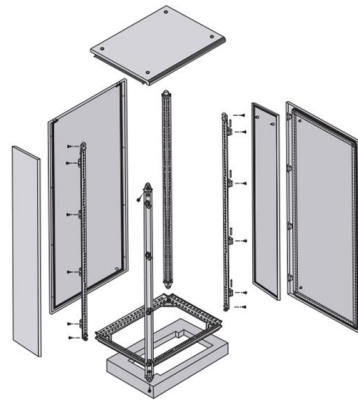

### Micro-trenches for optical fibre , ADI Technical Solutions

After inserting the cable, we proceed to pour concrete into the trench and, finally, we add signage with blue paint or metal plates. OPTICAL FIBRE THROUGH MICRO

### Home

A fast and precise approach of fiber optic installation THE Trencher is equipped with Germany Rexroth Hydrostatic Pump which is special tuned and commissioned to the best performance and matching



### Optic fiber trenching machine

Types of Optic Fiber Trenching Machines Optic fiber trenching machines are essential for installing fiber optic cables underground, enabling high-speed internet and communication networks. The choice of



### FIBER NETWORK - MYANMAR NETCOM



Fiber Installation and Network Design: Our experts handle the entire process, from laying Fiber optic cables to designing and implementing your network infrastructure.

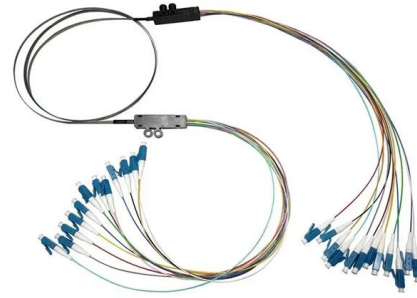

### Myanmar Singapore Submarine Fiber Optic Cable Project

It is reported that the Myanmar-Singapore International Submarine Fiber Optic Cable Laying Project will be under construction.

### MDEG , Myanmar Development Engineering Group Co.,

MDEG Co., Ltd., founded by senior engineers who have at least 17 years of in service experiences in MPT Operator (Myanma Post and Telecom). As



### Fiber optic network installation in the ground

Learn how fiber optic networks are installed in the ground. This article explains common underground installation methods and



## Fiber Optic & TelCo

Tesmec trenchers are a clean and fast technology for in-line excavations for the installation of urban fiber optic networks (FTTx), suburban networks (city rings)



## Fiber optics installation in the Middle East with

Environmental limitations: Micro trenching process is sometimes the only solution to defeat environmental challenges of the jobsite where it's somehow impossible to



## Cable Trenching Solutions , Efficient and Precise

Discover KEMROC's advanced cable trenching solutions for efficient and precise trenching. Ideal for utility installations and micro trenching projects.



## Microtrenching: A new and improved way to install fiber

In recent years, microtrenching has become an attractive way for urban developers to install fiber optic cable in heavily congested areas. It's less invasive than



### **Cable Fiber Optic Trenching Machine for Digging Trenches**

Self-propelled chain ditching machine adopts chain belt scraper structure, which can be ditched and slotted on any type of soil. Self-propelled chain ditching machine



### **Merry Mesh Network Integration , Home**

Merry Mesh Network Integration Company Limited was founded in 2007 with the aim to secure projects in Myanmar as well as to provide user-friendly turnkey

### **Top 20 Cabling and Fibre Optics Companies in Myanmar**

Search results of Top 20 Cabling and Fibre Optics Companies in Myanmar, near me. Listings are verified with accurate business information.



### **Vermeer Microtrenching Solutions for Utility Installation**

Complete microtrenching projects with the Vermeer reinstatement machine, a versatile tool for backfilling and reinstatement after conduit placement in



## Trenching

In contrast to the flush drilling method, trenching involves open civil engineering. With the help of a milling machine, a narrow trench is dug into the ground into which the construction

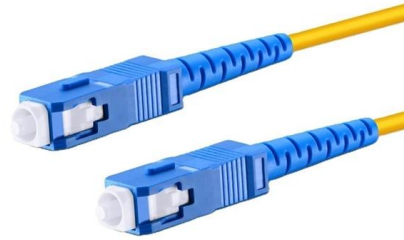

### Fiber Optic Cable-Laying Micro Trenching

The method we developed for fiber optic cable-laying micro trenching is based on our Nextec diamond grooving machine, which is a microgrooving version. Traditional microgrooving is a great technology

### Fiber Optic, Trencher , Tesmec

Tesmec trenchers are used for the installation of underground conduits for telecommunication networks. We provide a complete range of clean and fast

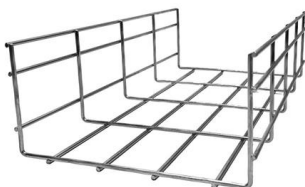

### Fibre Optic Trenching Machines , AFT Trenchers

Fibre optic trenching is a critical step in establishing reliable communication networks. Accurate trenches are essential for safely housing fibre optic cables,



### Fiber optic trench digging machine

Find efficient fiber optic trench digging machines for your projects. Durable, reliable, and designed for precision trenching. Perfect for pipeline and cable laying.



### Microtrenching Accelerates Fiber

INTRODUCTION There are many ways to build and deploy fiber optic cables and each has pros and cons when considering cost, speed, safety, and complexity. This white paper focuses on the

### Micro-Trenching for glass fibre laying - milling instead of

Micro-Trenching with the trenching machines from LiBa Glass fibre is the future. Data is transmitted much faster than is possible with copper. Not only the Internet, but



### Cable Fiber Optic Trenching Machine for Digging Trenches

Looking for a reliable and efficient Cable Fiber Optic Trenching Machine for Digging Trenches? Look no further! Our factory produces high-quality machines to help you get the job done. Contact us today!



## Fiber optic cable laying

Laying underground cables such as fiber optic cables or digging trenches for irrigation systems or drainage, LIBA trenching. If a specific undertaking in the field of earthworks is to be realized, LIBA



## MT12 Microtrencher

Lay down fiber with minimal disruption to the surrounding area and speed up the microtrenching process with the MT12. Only from Ditch Witch.

## Contact Us

---

For datasheets, pricing, or custom high-speed optical interconnect solutions, please visit:  
<https://www.syropy.com.pl>