

Low Temperature Chamber Power Distribution Box





Low Temperature Chamber Power Distribution Box



Understanding the ATS Dual Power Distribution Box:

Discover the essentials of the ATS Dual Power Distribution Box, a pivotal component in low voltage power solutions. This guide delves into its

how to choose low voltage power distribution cabinet

Choosing a low-voltage power distribution cabinet is similar to choosing GIS, but the focus is on load capacity, safety, and adaptability for low

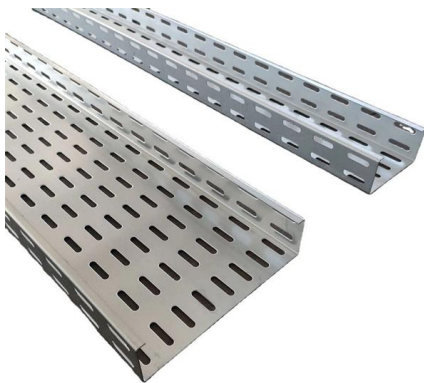

Power Qubes , Power Temp Systems

Discover the convenience of compact power distribution with Power Temp Systems' Power Qube, the space-saving portable power distribution boxes. Engineered for agility and dependability, our Power

Low Voltage Distribution Box

SP-JXF 3 Phase Motor Circuit Control Low Voltage Distribution Box Details YB series Outdoor 380V SMC Fiberglass Cable Junction Cabinet Details

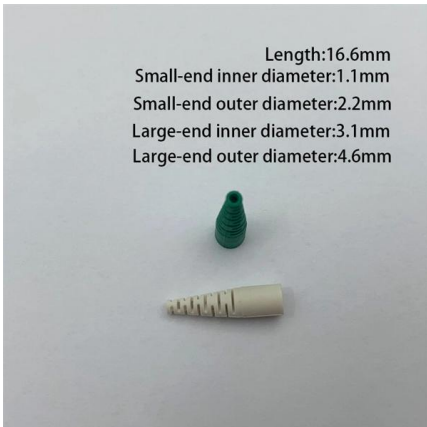

Thermal Distribution Simulation and Temperature Rise Prediction of Low

Abstract: Low-voltage comprehensive distribution boxes are widely used in distribution networks, and their temperature rise performance of being long-term power on directly affects the

Electrical AC/DC Power Distribution Box & Cabinet for Industry

Gopower is a manufacturer of industrial ac/dc electrical power distribution box/board transformer power unit. We manufacturer rtu in scada system and feeder remote terminal unit. Get a power distribution

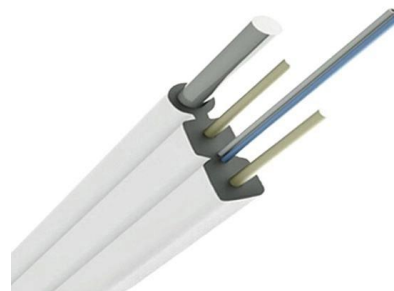

Distribution boxes - For modular and decentralised solutions

We provide you with information on our distribution boxes for download. Download our product catalogue for sensor-actuator cabling and circular connectors or our portfolio overview for



A Guide to Temporary Power Distribution Boxes , ATI

Temporary power distribution boxes are a popular method of providing electrical power to remote areas. Learn about the benefits of using



Catálogo SIMBOX WP LV10

Which is why products and systems featuring maximum safety and optimum efficiency are in demand. This comprehensive portfolio for low-voltage power distribution and electrical installation technology

GGD AC Low Voltage Power Distribution Cabinet

SP-JP intelligent low-voltage integrated distribution box has the advantages of strong integrity, small size, attractive appearance, safe and reliable operation, easy



How to Choose the Best High-Low Temperature Test Chamber?

Explore how DHT® High-Low Temperature Test Chambers deliver precise, rapid thermal cycling for aerospace, EVs, and pharma. Boost reliability and reduce test time.



Low Voltage Control Panel Board Power Distribution Box

GGD AC low voltage power distribution cabinet is applicable to power plants, transformer substations and industrial mine enterprises. It is used in



Power Distribution Equipment

Introduction Power Distribution Equipment is a term generally used to describe any apparatus used for the generation, transmission, distribution, or control of electrical energy. This section concentrates

Low Voltage Distribution Box Manufacturer & Supplier

A low voltage distribution box is an essential component used to receive, control, and distribute electrical power within systems operating below 1 kV. It houses circuit

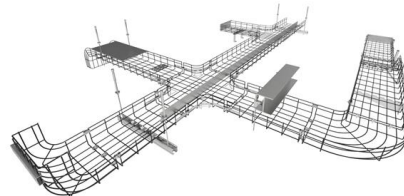

Distribution Boards

ABB's Low Voltage Products offering encompasses a wide range of electrical products designed to ensure the safe and efficient distribution and management of electrical power in various applications.



High Low Temperature Test Chamber , Labtech

High Low temperature test chamber is suitable for aerospace products, all kinds of electronic components and materials in high temperature, low temperature or



JXF low-voltage distribution box

We will present the performance, safe operation methods, and technical parameters of JXF low-voltage distribution box

A Complete Guide to LV Distribution Board , CHINT global

LV distribution boards, part of the electrical distribution system, securely distribute low-voltage power to facility circuits.

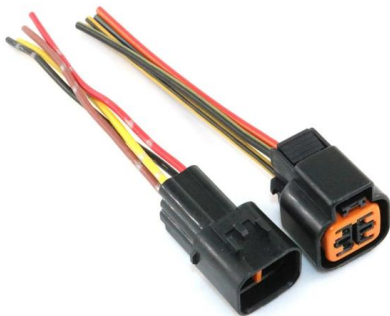

xComfort Compact Distribution Boxes

KLV energy compact distribution boxes now provides even more flexibility. The family is complemented thanks to new 5-row flush-mounted and hollow-wall distribution boards with up to 60 modules plus 10



MNS Low Voltage Distribution Board and Power Cabinet

-- From the sub distribution to factory power supply, from the general industry to the marine, nuclear power plant, MNS® power distribution box can provide high security, high reliability of professional

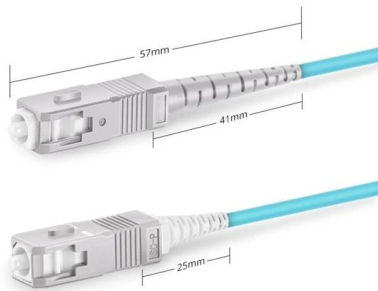

Simplex SC UPC

Low voltage Distribution Box Monitoring

In this Paper, the primary focus is on the distribution box health monitoring from which load power distribution monitoring is done. Distribution box is one from which power is distributed to low level.

Understanding the Essentials of Low Voltage

Low voltage distribution cabinets are a critical component of modern electrical systems, ensuring the safe and efficient distribution of power across



Understanding Distribution Boxes: A Comprehensive Guide

A distribution box, also known as a power distribution box or electrical distribution box, is used to distribute electrical power safely to multiple



Best Material for LV Distribution Box , Axis Electricals

What is an Electrical Distribution Box? A distribution box is a key component of an electrical supply system. From a single, common enclosure, it

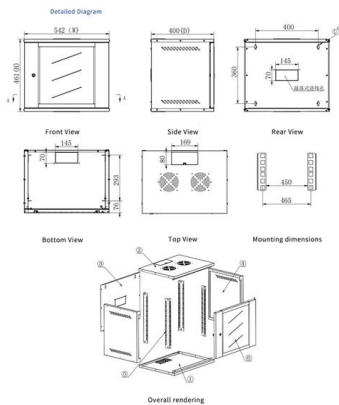

Custom Dustproof Low Voltage Switchgear Distribution Cabinet

Custom Dustproof Low Voltage Switchgear Distribution Cabinet Power Box is a modular system of electrical components designed to control, protect, and isolate circuits. The switchgear enables safe

Energy switchgear assembly POWER DISTRIBUTION BOARDS

In order to minimise disruptive, low-frequency magnetic fields in Mi switchgear, N(PEN) conductors can be arranged in the area of the phase conductors in an EMC-friendly manner.



Explore Power Distribution Box Types and Functions

Power distribution boxes are used in commercial and residential buildings and are part of the electrical system, also known as switchboards.



Expo Panels - Event, Stage Power Distribution Boxes -

Our Expo Panels provide portable power distribution solutions for indoor event centers including conventions, concerts, trade shows and more. From standard

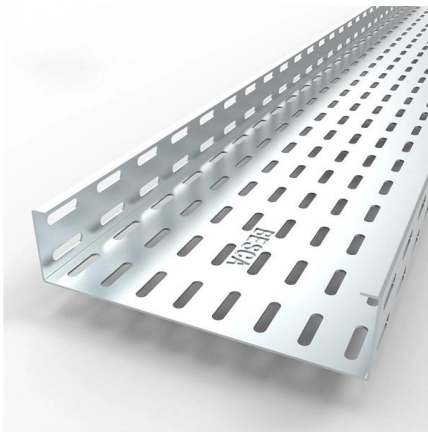

Low Voltage Power Distribution Cabinets Manufacturer,

LXL low-voltage power distribution box is suitable for three-phase four-wire or three-phase five-wire power systems with AC 50Hz and rated working voltage of 660V

Contact Us

For datasheets, pricing, or custom high-speed optical interconnect solutions, please visit:
<https://www.syropy.com.pl>