

Liechtenstein Low Voltage Complete Equipment Anti- tracking

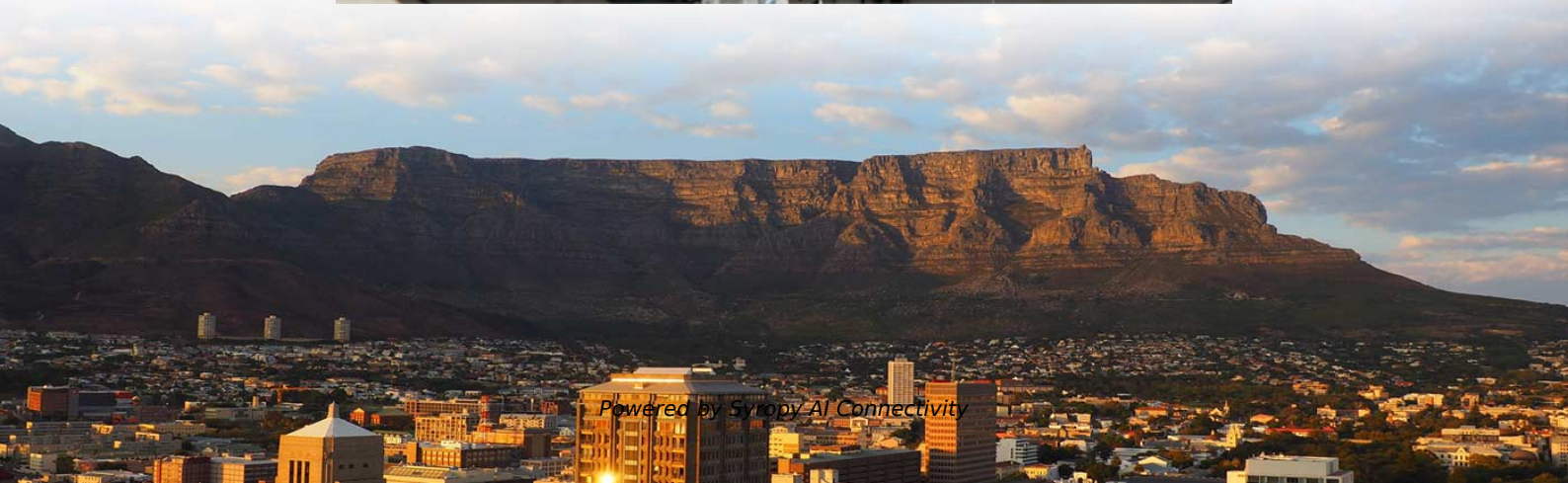



Liechtenstein Low Voltage Complete Equipment Anti-tracking



Anti-Tracking Cables: Reliable High-Voltage Solutions

Discover our Anti-Tracking Cables, designed to prevent electrical tracking and ensure safety and reliability in high-voltage applications.

Everything that you need in a complete low voltage rescue kit

Any worksite that involves a low voltage electrical system needs a low voltage rescue kit on site. This kit should be probably stocked with high-quality equipment, and there should be an adequate number of



What is Considered Low Voltage? Complete Guide (2025)

Understand what is considered low voltage, its safety features, and applications across different technologies and industries.

Low Voltage Directive Compliance: Complete Guide , QIMA

The Low Voltage Directive sets safety requirements for a wide range of electrical products sold in the EU. Learn what products are covered, what the LVD

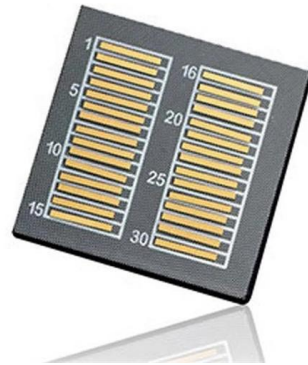

Liechtenstein

Liechtenstein's measures to combat money laundering and terrorist financing This report provides a summary of the anti-money laundering and

Liechtenstein: Anti-Money Laundering and Combating the Financing of

This Technical Note evaluates the state of Anti-Money Laundering and Combating the Financing of Terrorism in Liechtenstein. Liechtenstein has made significant steps and achieved



Liechtenstein Low Voltage Protection and Control Market (2025-2031)

Liechtenstein Low Voltage Protection and Control Industry Life Cycle Historical Data and Forecast of Liechtenstein Low Voltage Protection and Control Market Revenues & Volume By Product Type for



Low Voltage Protection and Control Devices Trends and Forecast

This report provides comprehensive coverage of the low voltage protection and control devices market, segmented by application (residential, commercial, industrial), type (protection



A new edition of CU TR 004/2011 "On the safety of low

A low-voltage equipment batch is a set of low-voltage equipment units of the same name and/or designation, produced within a certain period of time

NarcNton Signal shielding device Anti-tracking signal interceptor

We can deliver the NarcNton Signal shielding device Anti-tracking signal interceptor Vehicle GPS signal interceptor Simple installation shielding device speedily without the hassle of shipping, customs or



redundancy_reduction_longdoc/vocabulary_pubmed.json at master ·

This is the official code for the paper 'Systematically Exploring Redundancy Reduction in Summarizing Long Documents'. - Wendy-Xiao/redundancy_reduction_longdoc



Lichtenstein radar

Early FuG 202 Lichtenstein B/C units were not deployed until 1942. They operated at a maximum RF output power of 1.5 kW, on the 61 cm wavelength (490 MHz, or



The complete portfolio for low-voltage power distribution

Whether in industrial applications or in the infrastructure - our comprehensive portfolio of products and systems offers safe, flexible and efficient possibilities of application for low-voltage power distribution



MONEYVAL(2022)6 SUMM Liechtenstein

MONEYVAL(2022)6_SUMM 1. This report provides a summary of the anti-money laundering and combating financing of terrorism (AML/CFT) measures in place in Liechtenstein as at the date of the

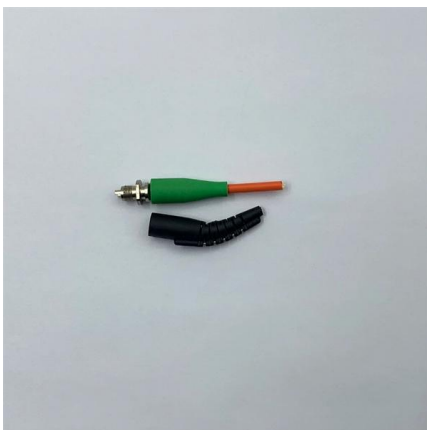
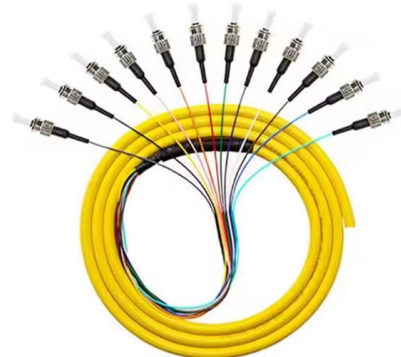

Low Voltage Directive (2014/35/EU)

Read this guide to learn what you need to know about the low Voltage Directive (2014/35/EU), and how to ensure your products comply.



Adaptronic Energy Equipment Supplied In Liechtenstein

The basic version of the KT 410 low-voltage wiring tester includes 2048 test points (expandable to 16,384) and is ideal for testing with a high number of test points. The KT 410 low-voltage wiring tester



Electrical tracking, erosion and flammability resistance of high

Ensuring the fire safety of high voltage (HV) outdoor insulators is key to maintain the reliable operation of the electrical grid. This requires the careful selection of suitable polymeric

Electronic Surveillance and Countermeasure Solutions

We bring a differentiated level of performance and enable rapid deployment of end equipment for electronic protection, electronic support, and electronic countermeasures. Superior Detection:

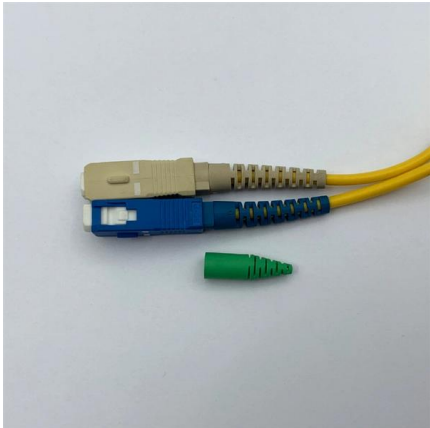

List of Products and HS Codes Requiring TR CU 004/2011 LVD

List of Products with HS Codes Subject to TR CU 004/2011 Certification Low-Voltage Devices (LVD) If your business involves the production or import of electrical equipment, securing



Various Applications for Voltage-Tracking LDO

Voltage-tracking LDO offers full protection features (short-to-GND, short-to-battery, overload protection, thermal protection and others) and ultra-accurate output tracking voltage.

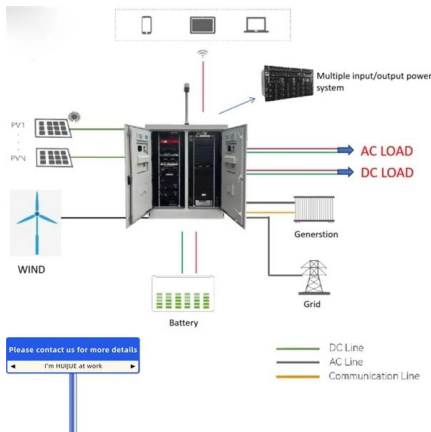

What Is LV Switchgear? A Complete Guide to Low

LV switchgear is essential for safe and efficient low-voltage power distribution. Learn about its components, applications, standards, and why it

Liechtenstein Low Voltage Protection and Control Market (2025-2031)

Liechtenstein Low Voltage Protection and Control Market is expected to grow during 2025-2031

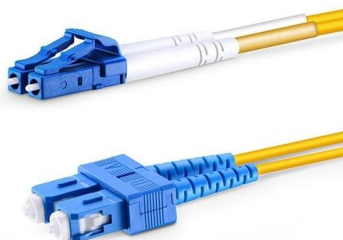

Technical Management and Risk Prevention and Control of High and Low

This paper comprehensively explores the technical management and risk prevention of high and low voltage complete sets of equipment in power engineering. It elaborates on technical



Directive

Directive 2014/35/EU of the European Parliament and of the Council of 26 February 2014 on the harmonisation of the laws of the Member States relating to the making available on the market of



Foreign Trade of Liechtenstein of NCE low-voltage protection

Comex Reports Liechtenstein 85 - electrical machinery and equipment and parts thereof; sound recorders and reproducers, television image and sound recorders and reproducers, and parts and

Contact Us

For datasheets, pricing, or custom high-speed optical interconnect solutions, please visit:
<https://www.syropy.com.pl>