

# **In-wall distribution box housing**

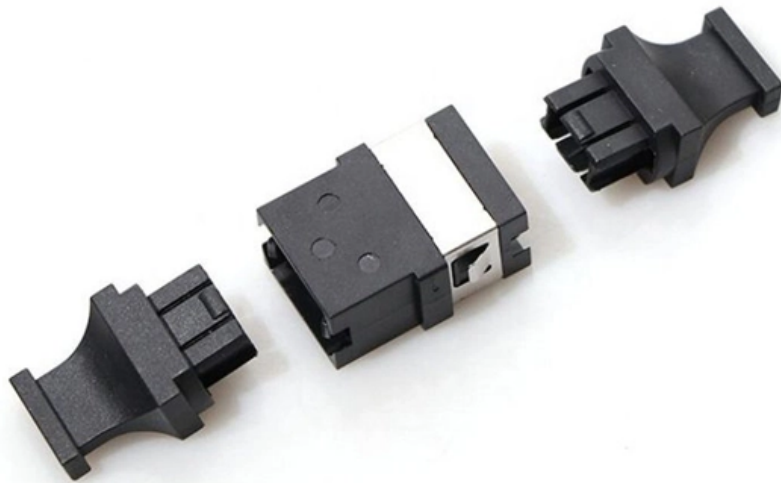



## In-wall distribution box housing

---



### Riser Distribution Terminal Housings Wall-Mount Box

Corning OptiSheath® riser distribution terminals are small, simple interconnects between the distribution network riser cable and horizontal drop cables. These

### Electrical Distribution Boxes for Power Distribution , Wieland

The Wieland distribution boxes accommodate all required components of the electrical installation as well as building automation on a project-specific basis. The distributor boxes can be viewed as a



#### Pre-Terminated Patch Panel

Standard 19" width    Max 144 fibers in 1U    Ultra-High Density Ready

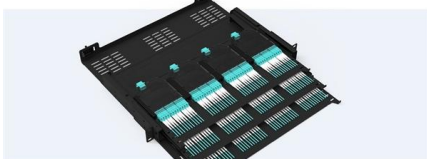

Dual-lead, easy install & maintain



Lightweight ABS MPO cassette



Premium sheet metal with matte coating

### Wall-Mounted vs. Floor-Mounted Distribution Boxes:

Compare wall-mounted vs. floor-mounted distribution boxes. Learn their key differences, uses, pros & cons to choose the right one for your space

### The Ultimate Guide to Distribution Box Types

Discover the key types of distribution boxes with NUOMAK's comprehensive guide. Learn about Main Distribution Boards (MDB), Consumer Units, Transfer



### Distribution Boxes Types - The Complete Guide

The power distribution boxes deliver electricity from the main electrical main to other circuits. Several distribution boxes are designed for specific use in

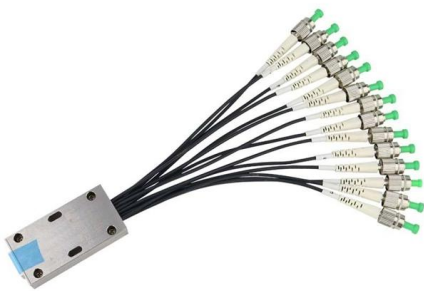

### ABS plastic electrical distribution box for wall mounting with 18

Distribution box for embedding in ABS plastic, with 18 modules in line. The distribution box allows the mounting of standard 18mm wide modules on a DIN rail. Robust



### How to Choose a House Distribution Box

Choosing the house distribution box that best fits your home is important for your safety and the efficiency of your electrical system. It facilitates the flow of electricity, guards appliances, and

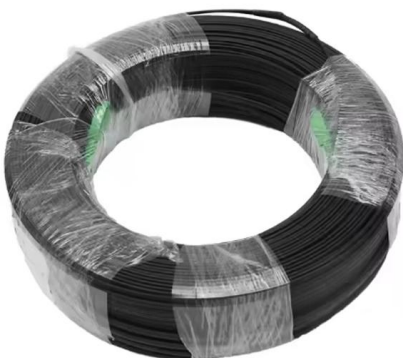



### Power Distribution Boxes Explained Simply

Learn what a power distribution box is, how it works, key components, types, and why it's vital for safe and efficient electrical systems.



### Amazon : Wall Enclosure

Explore a wide range of in-wall enclosures for media, networking, and electrical applications. Shop durable options today.

### Custom Power Distribution Box Manufacturers , J& HW

We deliver tailored solutions for electrical power distribution boxes and distribution electrical boxes, avoiding unnecessary features and ensuring a perfect fit for your

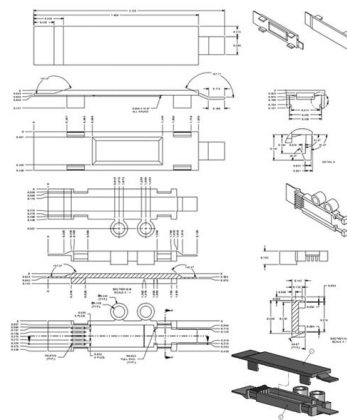

### Wall Boxes

Wall Boxes L-Series AM-W1 Wall Box L-Series AM-W1 Wall Box has been designed to house 1 L-Series Adapter Plate.



## How to Choose the Right Wall-Mount Box for Compact

Discover how to select the perfect wall-mount box for machinery and control panels. Learn about footprint optimization, IP rating selection, and

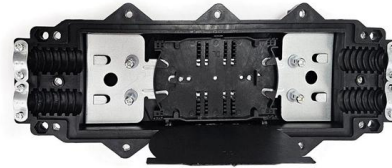

## 4 Port Indoor / Outdoor fiber optic Distribution Box FTTX

Subscriber Distribution box for detached houses. Is normally mounted on the house wall and forms the splicing point between the incoming street cable and the



## DISTRIBUTION BOX

Our distribution boxes come in various configurations suitable for wall-mounting, floor-standing, or pole-mounting. This flexibility allows for optimal positioning in



## Understanding Distribution Boxes:A Comprehensive Guide

A distribution boxes is an essential device that manages the safe and efficient flow of electrical power throughout different areas of a building or facility.



## Power Distribution Units - Tailored Solutions , INDU-ELECTRIC®



Whether large energy and main Power Distribution Units, portable sub-distribution boxes, compact units or power outlet blocks - we offer the right solution for your requirements.



### What is the Internal Structure of The Distribution Box

Learn about the internal structure of a distribution box, its components, functions, and key types. Understand its role in electrical systems

### Distribution enclosure, Distribution box

Find your distribution enclosure easily amongst the 112 products from the leading brands (RITTAL, BOPLA, ROSE, ) on DirectIndustry, the industry specialist for your professional purchases.



### Explore Power Distribution Box Types and Functions

Power distribution boxes are used in commercial and residential buildings and are part of the electrical system, also known as switchboards.



## A comprehensive understanding of distribution box

What is a Distribution Box? A key component in electrical distribution that houses protective devices like circuit breakers, RCBOs, or AFDDs--ensuring



### DISBOX-K flush-mounted distribution box IP40

The DISBOX-K series distribution boxes are manufactured with a wall box made of ABS and a front frame and door made of sheet steel. The door can be hinged on

### BC54151-LD , Box/housing for built-in mounting in the

Description: OCTAGONAL BOX 1-1/2IN LOOMEX REWORK. UPC: 622538411143. Made or assembled in Canada. 4 inches octagonal box 1-1/2 inches depth 15



### Distribution enclosures » all types & all information

Schrack Technik offers an integrated range of enclosures, housings and equipment bodies: from small consumer units to low-voltage main distribution boards, we



### IP54 wall distribution box

Wall mounted electrical distribution box. Metal cabinet type design with door. IP54 environmental protection, to install the distribution box indoors. Entirely empty box, except for a mounting plate fixed



### Distribution Boxes Explained: Types, Functions, and

Learn about distribution boxes, their types, functions, and safety features to ensure efficient and secure electrical power distribution in any building.

### Wall Boxes

CommScope offers a complete line of easy-to-use access terminals, copper and fiber splice closures, patch closures and accessories to speed deployment.



### Electrical distribution boards , Gewiss

The heart of the GEWISS offer is represented by energy connection, distribution, derivation and transport systems. A complete range of innovative products, Made



## Distribution Box Guide: Types, Components & Solutions

It acts as a protective enclosure that houses several key components, such as circuit breakers, fuses, and bus bars. These components work together

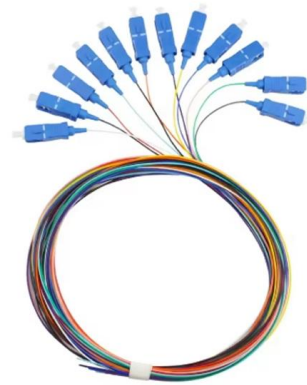

## Contact Us

---

For datasheets, pricing, or custom high-speed optical interconnect solutions, please visit:  
<https://www.syropy.com.pl>