

# How to remove the pigtail cable

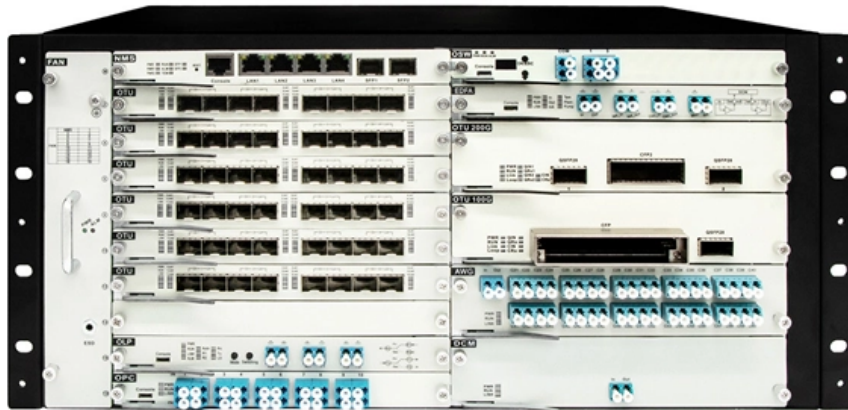



## How to remove the pigtail cable

---



### Step-by-Step Guide On Removing Wires From A Connector

Learn how to safely remove wires from a connector with this step-by-step guide. Follow expert tips for a seamless process.

### How to Install a Pigtail Electrical Receptacle

The pigtail wire then only carries the current necessary to power the single receptacle to which it is connected, isolating the device from the primary circuit flow. This design means that if the



### How Do You Replace a Pigtail Connector: A Step-by-Step Guide

3. What are the steps involved in replacing a pigtail connector? Replacing a pigtail connector requires careful attention and following specific steps. First, turn off the power supply to

### Depinning automotive electrical connectors: How to remove the pin

In this video, we demonstrate how to depin and remove the terminals from the most common, top-selling automotive electrical connectors. 0:25 Y210B3 - front turn signal, running lamp, tail lamp, ac



### How To Repair A Damage Pigtail Plug?

Key components involved include cables, pigtail connectors, and terminals. For effective repair, viewers are advised to obtain basic tools, including



### How To Repair Pigtail Connector?

Understanding how to effectively repair automotive electrical connectors can greatly enhance functionality and safety in vehicles. For visual



### Step-by-Step Guide: How to De-pin Connectors like a Pro

Ever found yourself needing to disassemble connectors to repair or replace cables, but unsure how to go about it? This video is an easy-to-follow, step-by-step guide to removing and depinning





## Electrical Pigtail: 6 Steps Wiring Guide for Safe

Learn how to create an electrical pigtail for safe and secure wiring connections. Follow our step-by-step guide and essential tools list.



### How to Pigtail Electrical Wires

Redo if needed for a solid connection. Hot Pigtail: Follow the same steps as the neutral pigtail. 3 Ensuring Solid Connections Twist the wire nut until the wires start twisting together.

### Pigtail Wires: How To Make Electrical Pigtail Wire

Tug both cables to ensure the joint is firm. However, nylon closed-end and pigtail connectors operate differently; you don't have to strip the wires to

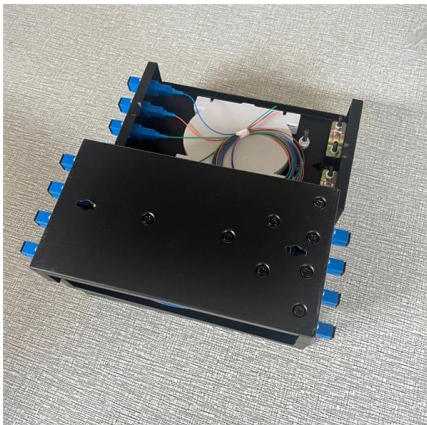

### Pig tail wire removal

This video will show you how to remove wires from pig tail connector and also how to unplug pig tail connector, thanks for watching.

### How to Remove Pigtail Catheter? "A



Pigtail Catheter is one of important procedure in Pulmonary, Internal medicine and critical care medicine department. This is live procedure and demonstration of pigtail catheter removal.

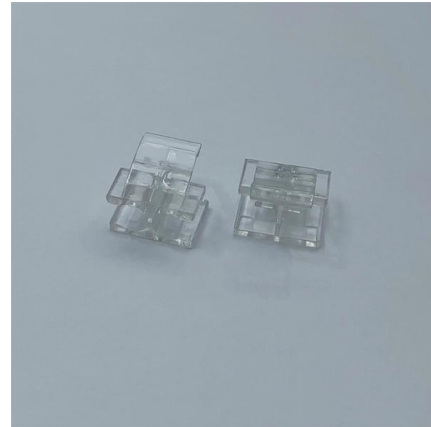

### How to replace pigtail connector? : r/MechanicAdvice

I need to remove the wire from this new connector, and replace it with the existing wire from the car. Can someone explain or perhaps post video showing how to do it with this style connector?

### Automotive Pigtail & Connectors , How to Release Terminals, De-Pin

#automotiveconnectors #depinconnector Here are a few clips demonstrating how to successfully release the terminals/pins from an automotive wiring harness conn



### How to replace pigtail connector? : r/MechanicAdvice

The issue is removing the wire that's there so I can replace it with the existing wiring. The wire seems to be connected to the silver plating inside and I'm not sure how to detach.





### remove a broken pigtail connector from cable ? : r/computerrepair

I was replacing the wifi card on my partner's laptop when the pigtail connector came loose from the card (explains why it wasn't working properly) and is now stuck on the cable.

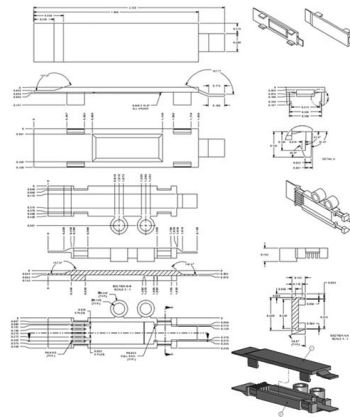

### What Is a Pigtail Wire and When Do You Need One?

When multiple cables enter a junction box, the conductors (hot, neutral, and ground) are twisted together and secured with a wire nut. The pigtail emerges from this consolidated splice, providing a single

### How to Make Pigtail Wire Connections , Angi

A pigtail electrical wire connector is a simple DIY project, whether you need to extend a short wire or connect neutral, hot, and ground wires to a circuit.

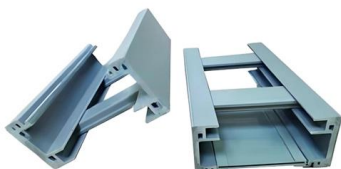
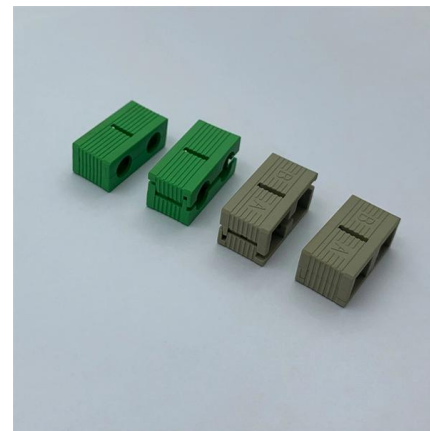

### De-Pin and Re-Pin , FindPigtails

How to de-pin/re-pin automotive connectors in 7 easy steps like a pigtail expert. Find the right tools, remove the front cap, release the catch,



## How to Make Pigtail Electrical Wire Connections

How to Make a Pigtail Wire The National Electric Code requires a pigtail wire to be least six inches long. Electricians often cut their own pigtails

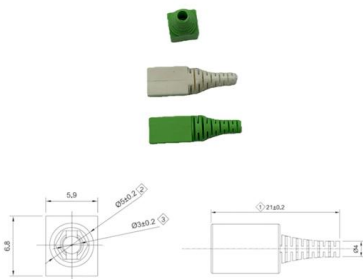

## How to repair automotive wire harness connectors, pigtails: B27A3

Quick Video Demonstration on how to repair a wiring harness connector, pigtail, plug. This is the de-pin, re-pin method Refer to our website to view what this part # (B27A3) can be used for.

## How to Replace a Pigtail Connector

Learn the proper, safe techniques for replacing damaged electrical pigtail connectors, ensuring a durable, verified repair.



## How To Repair Pigtail Connector?

It outlines seven easy steps to replace a pigtail connector, making it accessible for DIY enthusiasts and individuals dealing with electrical issues. Key



**Was wondering if it's okay to cut pig tails :  
r/sffpc**

I was wondering if it's okay to cut the pigtailed off GPU vga cables from the power supply unfortunately with my case being slim it won't allow me to properly close the side panel with the VGA cable pigtailed



## Contact Us

---

For datasheets, pricing, or custom high-speed optical interconnect solutions, please visit:  
<https://www.syropy.com.pl>