

Fireproof cable trays for Laos





Fireproof cable trays for Laos



FIRE RESISTANT PROOF CABLE TRAY, DIN STANDARD E90

Cablofil Cable Basket - Fire Resistant Cable Tray for FP (Fire Proof) Cables Cablofil cable tray is the preferred choice for the cable containment of low and high voltage electric cables where fire

301 Moved Permanently

Moved Permanently The document has been permanently moved.



Fireproof Cable Tray Manufacturers & Suppliers

Cable Tray manufacturer / supplier in China, offering China Factory Direct Sale Customizable Perforated Cable Tray, Price Competitive Custom Size Galvanized Perforated Cable Tray, OEM Customized

Metal Cable Tray & Fireproof Cable Tray from China Factory , ecer

Buy quality Metal Cable Tray and Fireproof Cable Tray, Langfang Dongkuo Electrical Equipment Co., Ltd - Manufacturer of Perforated Cable Tray from China



On Sale Fireproof Cable Tray Powder Coated Surface , Alibaba

Shop high-quality fireproof cable trays from reliable suppliers. Durable, perforated, and powder-coated for indoor and outdoor use. Bulk orders welcome.

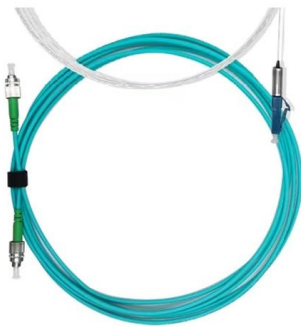

Fire protection for cables & cable trays , Flamro

With our fire protection for cable systems, we ensure that your lines meet the highest safety standards and are reliably protected in the event of an emergency.



Fireproof cable trays

China Fireproof cable trays catalog of FRP Fiberglass Cable Tray Manufacturer GRP Wire Cable Ladder Tray, Manufacture Aluminum Alloy Cable Trunking Ventilated Perforated Fireproofing Cable Tray





Fireproof Cable Tray, Fireproof Cable Tray direct from Langfang

Our Fire-prevent Cable Tray is also highly impact-resistant, which means it can withstand heavy loads and protect your cables.

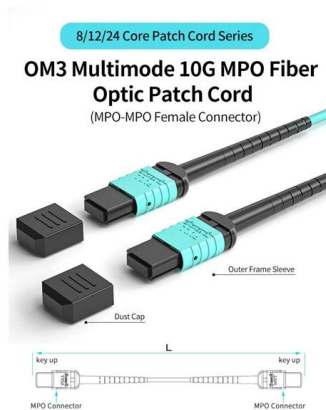
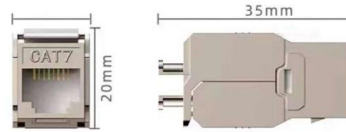

Factory Direct Sales Fireproof Cable Trays/Perforated Cable Trays for

Our company has an advanced cable tray one-time molding production line, an automatic laser cutting production line, a laser welding production line, an automatic spraying and galvanizing production

Factory Direct Sales Fireproof and Fire-Resistant Trough-Type Cable

Finishes & Materials: Our Fireproof Cable Tray boasts an exquisite selection of premium finishes that cater to your every need, including HDG, Pre-galvanized, Electronic-galvanized, and Powder



Top 10 Recommended Fireproof Cable Tray Manufacturers for 2025

This technology enterprise, deeply engaged in the cable tray field, has built a complete service system from research and development to after-sales. Walking into its production base, CNC



Factory Direct Sales Fireproof Spray Coated Cable Tray Fire

Factory Direct Sales Fireproof Spray Coated Cable Tray Fire Protection Perforated Steel Fireproof Tray No reviews yet certified Shandong Xuanlin Metal Materials Co., Ltd. Multispecialty Supplier

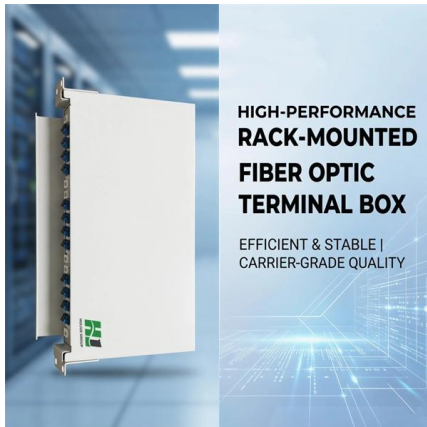

Galvanized Fireproof Cable Trays, Factory Direct Sales of Galvanized

250 kg, 216 kg, 200kg, 150 kg, 120 kg, 129 kg, 100kgMax. Working Load Cable Laying, Cable Support, Cable Wiring, Construction, Industrial, Managing Cables, NetworkApplication Liaocheng,ChinaPlace

Factory Direct Sales Waterproof and Fireproof Channel

4. Easy installation and maintenance: fireproof cable tray is easy to install, convenient and fast, and maintenance, only need to carry out regular inspection



Cable Tray Manufacturers & Suppliers in Laos , Trademo

Find and discover Cable Tray manufacturers and suppliers for all products in Laos, featuring details on their shipment activities, trade volumes, trading partners, and more.



Factory Direct Sales Aluminum /Galvanized/Fireproof Cable Trays

There are galvanized, hot-dipped zinc, steel, stainless steel, aluminum, FRP etc variety materials for customers to choose, And also can according to customer requirements to customize a variety of

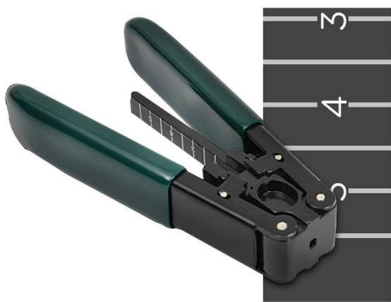
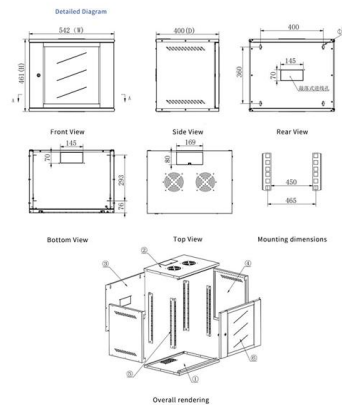

Factory Direct Sales Aluminum /Galvanized/Fireproof Cable Trays

Factory Direct Sales Aluminum /Galvanized/Fireproof Cable Trays, Find Details and Price about Cable Tray Cable Duct from Factory Direct Sales Aluminum /Galvanized/Fireproof Cable Trays - Liaocheng

Cable Tray, Cable Trunking, Cable Ladder, Perforated

Our high quality cable tray products include cable trunking, cable ladder, perforated cable tray, wire mesh cable tray, cable tray accessories and switchgear cabinet,

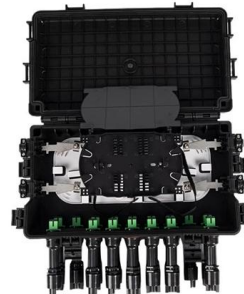

Cable Tray In Laos , Cable Tray Manufacturers Suppliers Exporters

We have a comprehensive range that helps us meet industry grades and customer requirements. As one of the noteworthy Cable Tray Exporters and Suppliers in Laos, we are right here to serve you as



Fireproof Cable Trays Acceptance: Standards for Safety

Ensure safety and durability with this comprehensive guide to fireproof cable trays acceptance. Learn coating processes, inspection standards, and



HDG Cable Trays in Laos Forest Pulp and Paper

Choosing the right cable management system is pivotal for infrastructure projects, especially in challenging climates like Laos. The " Laos Forest Pulp and Paper

Fireproof Ventilated Cable Trays

Discover high-quality fireproof ventilated cable tray designed for efficient cable management, offering durability and easy installation. Ideal for enhancing organizational systems in commercial settings.

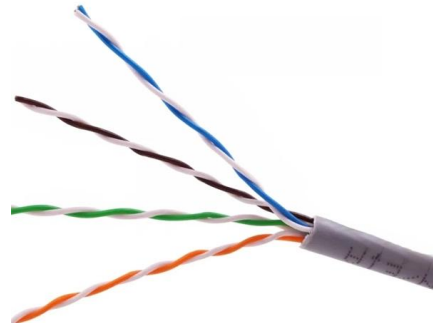

Technical Guidelines for Cable Tray Installation and

Periodically inspect outdoor trays for rust, moisture accumulation, or UV damage reproof trays require scheduled inspection for coating integrity and



Fireproof Cable Tray

Be a quality Fireproof Cable Tray supplier from China, we provide quality Fireproof Cable Tray for you



Fireproof Channel Cable Tray System

The fireproof channel cable tray system is produced by galvanized channel cable tray after processing surface treatment of a layer of fireproof coating. In addition,

Fire Resistant Cable Tray for Sale - 2026

Find top-rated fire resistant cable trays for sale with customizable options. Compare prices, MOQs, and supplier ratings. Click to explore verified suppliers and get the best deals in 2026.

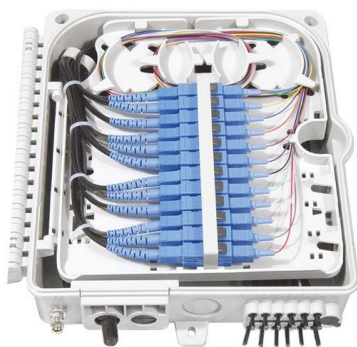

FRP fireproof cable tray in stock. Railing type tray, slot type tray

With over 16 years of professional expertise in the manufacturing and supply of cable trays, perforated cable trays, ladder-type cable trays, and cable trunking systems, we have delivered premium-quality



Fire-Resistant Cable Trays in High-Risk Environments

Explore the importance of fire-resistant cable trays in high-risk environments. Learn about the best materials and practices to



Contact Us

For datasheets, pricing, or custom high-speed optical interconnect solutions, please visit:

<https://www.syropy.com.pl>