

# **Distribution Box Circuit Breaker Model Design**





## Distribution Box Circuit Breaker Model Design

---



### Electric Distribution Box

A distribution board (also known as panelboard, breaker panel, electric panel, DB board or DB box) is a component of an electricity supply

### Electrical Distribution Fundamentals Design Guide Data Bulletin

Further, the solidly-grounded neutrals allow for ground currents to flow that can create interference in communications circuits (see Electric Power Distribution System Design, New York3



### Decoding the Breaker Box Schematic: A

A breaker box schematic typically includes information on the main service entrance, circuit breakers, electrical connections, and wiring configurations. It shows the

### Customization of a complete distribution box

The general process of customizing a complete set of distribution boxes: Requirement confirmation: Understand specific electrical parameters



### What is a Distribution Box? - A Comprehensive Guide

Key Components of a Electrical Distribution Box  
Circuit breakers are essential for protecting electrical systems by cutting off power during overloads or

### CAD Downloads

Eaton is an intelligent power management company dedicated to improving the quality of life and protecting the environment for people everywhere. We are



### Distribution Box and Selection Guide

Distribution Box Selection Guide This guide provides information on how to select the appropriate Distribution Box for Electric project. If you have any



## What is the Internal Structure of The Distribution Box

A distribution box is a key part of electrical systems in buildings. It helps control and distribute electricity to different areas. Inside, you'll find parts

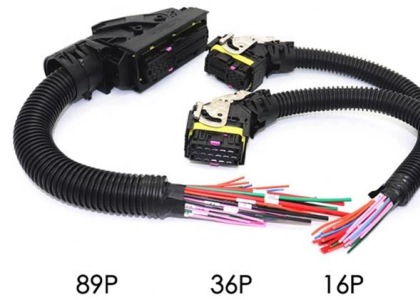

## Circuit Breaker SPICE Simulation.

This article reports on the development of a circuit-breaker model that can accurately represent circuit-breaker behaviour over a wide range of overcurrents. The



## Download CAD files for Electrical Distribution Products

Electrical Distribution CAD files Schneider Electric is a market leader in electrical distribution solutions. We design and manufacture a range of electrical products

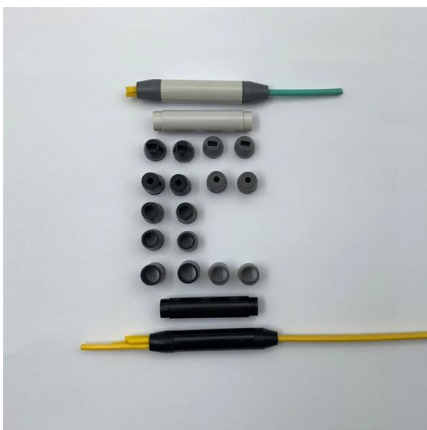
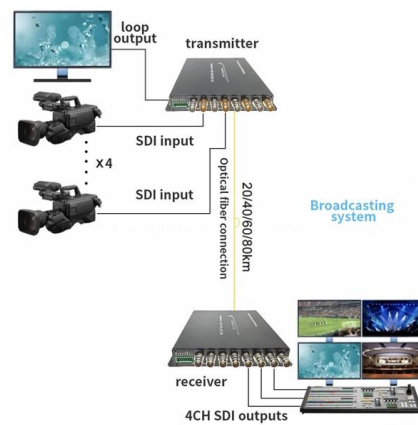

## Distribution Box: Types and Functions , Axis-Electricals

A distribution box ensures that electrical supply is distributed in the building, also known as a distribution board, panel board, breaker panel, or electric panel. It is



## Distribution board

A distribution board (also known as panelboard, circuit breaker panel, breaker panel, circuit breaker, electric panel, fuse box or DB box) is a component of an electricity supply system that divides an



## Circuit Breaker Distribution Panel

Premium Electric electricians on how your circuit breaker distribution panel works, an easy-to follow guide for beginners.

## Understanding Circuit Breaker Wiring Configurations in

Correct wiring methods for circuit breakers within distribution boxes are fundamental to ensuring electrical safety and compliance with established codes.

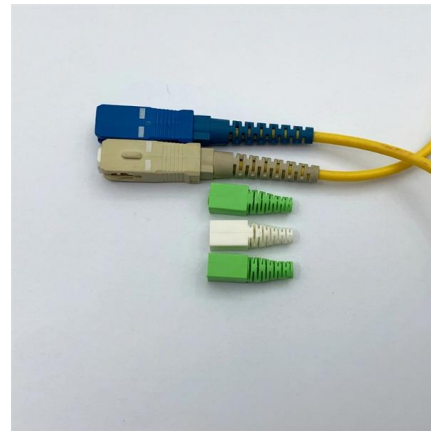

## CAD Downloads

We are guided by our commitment to do business right, to operate sustainably and to help our customers manage power - today and well into the future.

AutoCAD DWG format drawing of an MCB Box, plan, front, and side elevation 2D view for free download, DWG block for a Miniature Circuit Breaker, electrical



**(MCCB) Molded Case Circuit Breaker Box**

The CAD files and renderings posted to this website are created, uploaded and managed by third-party community members. This content and associated text is in no way sponsored by or



**Distribution Box (DB) circuit diagram.**

The subject of the article is a description of the operating principle of the new proposal of the selective circuit breaker, which is an extension of the existing



**Distribution Box Guide: Types, Components & Solutions**

What is a Distribution Box? A distribution box, or DB box, is a circuit breaker enclosure. It is a vital part and central hub of any electrical system. The



## Electric Panel Installation Method Statement , PDF

This document provides a method statement for installing and terminating electric panels and distribution boxes. It outlines 4 steps: 1) Pre-installation preparation



## The Complete Guide to Distribution Box: Installation, Types & More

Circuit additions are possible if the distribution box has adequate capacity and available spaces. However, you must ensure the total load doesn't exceed the box's rating and that all

## Electrical Distribution Box Design Guide

The document provides details for designing the electrical distribution box and circuits for a residence. It includes specifications for the main circuit breaker such



## Electrical Single Line Diagram of DB , AutoCAD Drawing

This AutoCAD DWG file includes a complete Single Line Diagram (SLD) of a Distribution Board, showing circuit breakers, wiring connections, and load



## Electrical Distribution Fundamentals Design Guide Data Bulletin

This guide discusses the main considerations that must be taken into account to obtain an optimal system design. Because the characteristics of each load, process, or other issue, are



### A step-by-step guide to wiring your breaker box

A breaker box, also known as a circuit breaker panel, is an essential component of any electrical system. It is responsible for distributing electricity throughout a

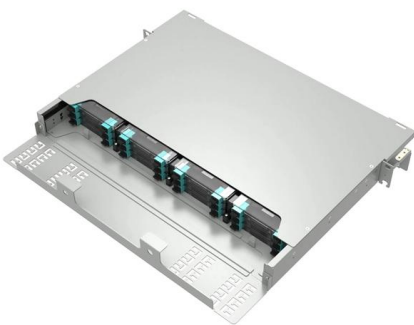

### Power Distribution Boxes Explained Simply

**Key Takeaways** A power distribution box (also called PDU or distro) directs electricity from a main source to multiple circuits. It acts like a hub or traffic

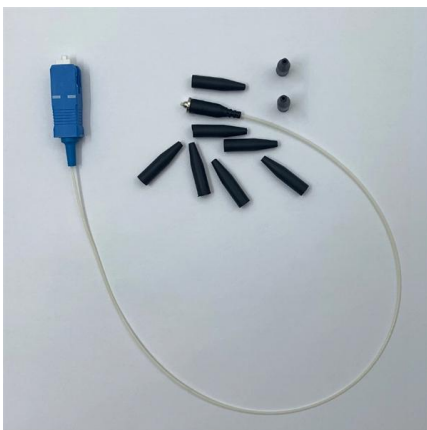

### Understanding Electrical DB Boxes: Your Ultimate Guide to Safety

Its primary function is to distribute electrical power from a single source to various circuits within a building. By housing circuit breakers or fuses, the DB box acts as the central hub for managing

Hier sollte eine Beschreibung angezeigt werden, diese Seite lässt dies jedoch nicht zu.

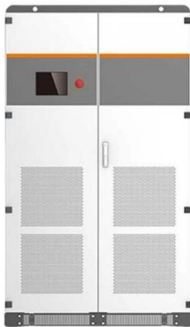
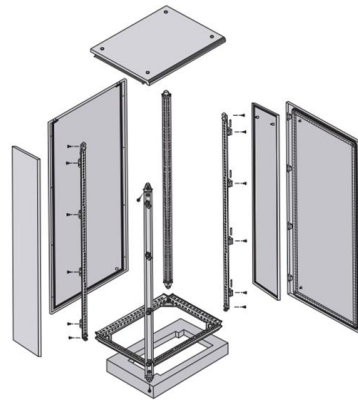

### **Download CAD files for Electrical Distribution Products**

Download Schneider Electric Electrical Distribution CAD files in over 40 different file formats

### **Distribution Board Design: Standards, Surge Protection**

Key Components of Efficient Distribution Board Design A distribution board relies on several critical components to ensure safety, reliability, and



## **Contact Us**

---

For datasheets, pricing, or custom high-speed optical interconnect solutions, please visit:  
<https://www.syropy.com.pl>