

Cost of Industrial-Grade Ring Network Switches

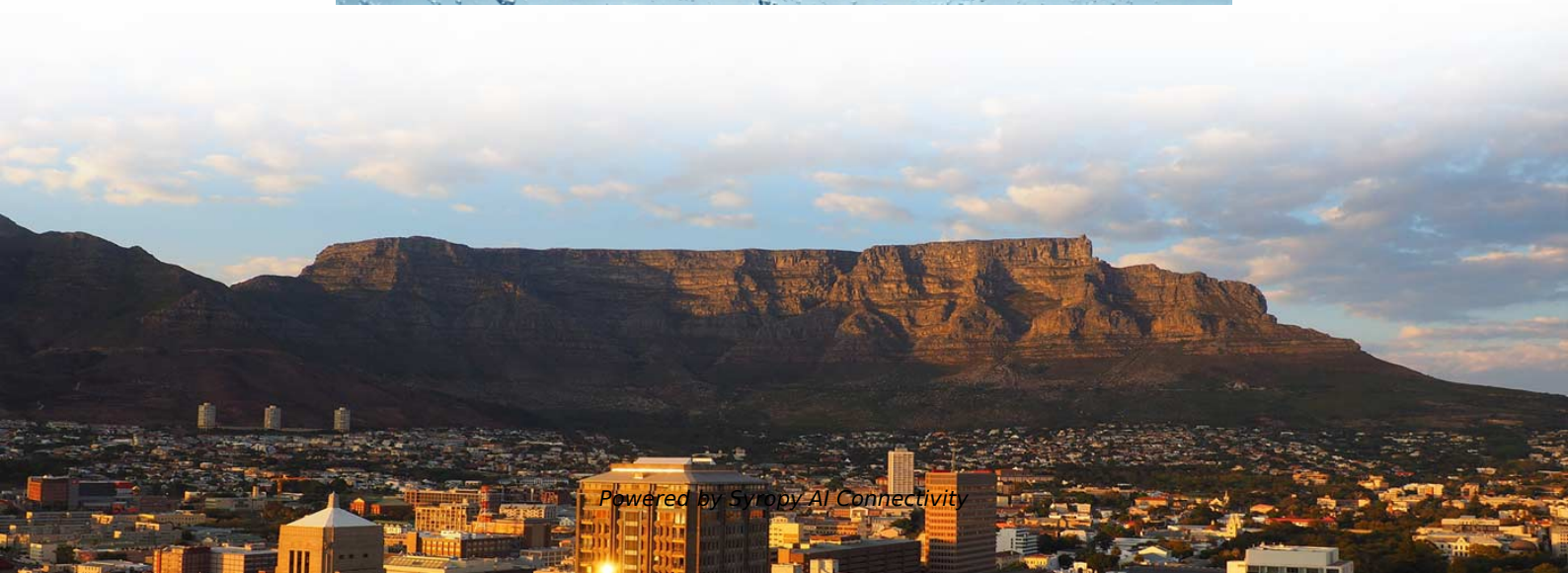

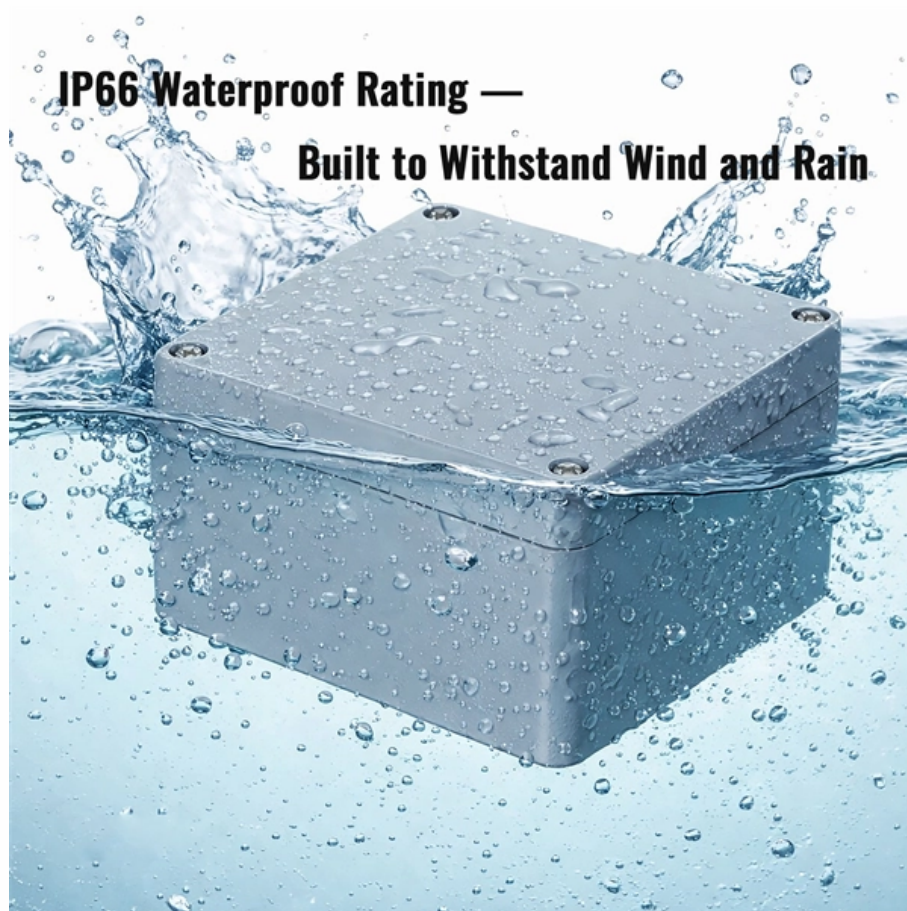

Cost of Industrial-Grade Ring Network Switches

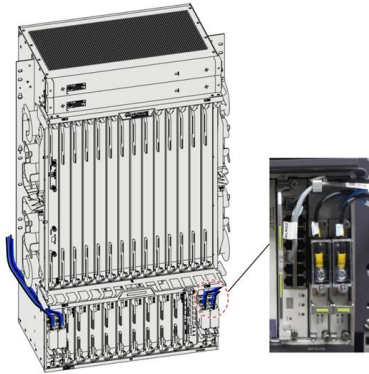

8GE+12SFP L2+ Industrial Fast Ring Managed Network

Robust Industrial Network Switch Specially designed for harsh industrial uses, hardened grade rugged IP40 aluminum housing, -40 to +75° C extreme

Industrial Lan switch how to group ring network

September 19, 2024 Industrial Lan switch how to group ring network In the industrial Internet of Things, the Industrial Lan Switch group ring network is an important network architecture method that can



Industrial Network Switches

Our ethernet network switches are built with industrial grade components, tested in-house & certified for reliable operation in harsh conditions. Shop now!

Industrial Ethernet Switches

Built to endure the demanding conditions of factories, transportation infrastructure, grid substations, and other harsh environments, Cisco Industrial Ethernet



Industrial Ethernet Switches - Cost-Effective,

WAGO's range of switches ensures the scalability of your ETHERNET network infrastructure, while providing outstanding electrical and mechanical



Industrial Ethernet Switches

Modernize your operations with Cisco Industrial Ethernet switches: Increase productivity, boost security, and empower industrial AI.



8+2 Ring Network Gigabit PoE Switch with SFP

Ring Network Gigabit PoE Switch is a flexible solution to increase efficiency and stability for power and network transmission in the long distance PoE networking





Real-time Redundant Ring Switch Industrial Ethernet Switch

Introduction The Real-time Redundant Ring Switch offers fault-tolerant industrial Ethernet with ring network topology. The built-in ICP DAS proprietary Cyber-Ring technology detects and recovers from

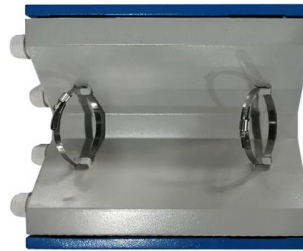

Types of Industrial Grade Network Switches

Learn about L2 and L3 Industrial Grade Network Switches, PoE vs non-PoE types, and how to choose the right rugged switch for your

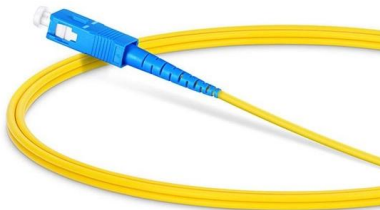

Industrial Switches - Cost-Effective, Redundant Network Solutions

Industrial Switches WAGO's range of switches ensures the scalability of your ETHERNET network infrastructure, while providing outstanding electrical and mechanical characteristics. Unmanaged and



Google

Checking your browser before accessing undefined Click here if you are not automatically redirected after 5 seconds. Checking your browser - reCAPTCHA



Industrial Ethernet Ring Topology Switches

Find reliable industrial ethernet ring topology switches with PoE+, DIN rail mounting, and rugged -40°C to 75°C operation. Click to explore top-rated suppliers and get competitive pricing for 2026.



ISF Series Ring-type Industrial Ethernet Switch

Price of ISF ring-type switches is much lower than that of managed switches, thus will significantly cut down equipment investment while not compromising network performance.



Industrial Ethernet Switch

ORing offers a comprehensive portfolio of rugged industrial Ethernet switches, from cost-effective unmanaged and PoE models to advanced Layer 2/3 managed switches enabling precise control. Our



Industrial Switches (ISW) , Extreme Networks

Extreme Industrial Switches are a family of ruggedized Layer 2 switches designed to operate under harsh environments and extended temperature conditions. They provide continuous uptime,



X-Ring Ethernet Industrial Ring Technology



Introduction to X-Ring Ethernet Industrial Ring
Technology X-Ring Ethernet Industrial Ring
Technology is supplied on the Case
Communications range of Industrial



Industrial Automation Ring Network Solution

Industrial Automation Ring Network Solution
Increase efficiency and ensure network flexibility,
performance, security, and resiliency for the
industrial network.

IFGS-620TF Industrial Ring Ethernet Switch , Planet

Industrial Ring Ethernet Switch Slim Type for
More Practicability and Convenience PLANET
IFGS-620TF is the first Unmanaged industrial-
grade Ring Ethernet



Industrial Ethernet

Industrial managed switches from B+B
SmartWorx deliver redundant, ultra-fast
recovery. With features such as IEEE 802.3x flow
control, redundant



Managed Industrial Ethernet Switches , Rugged DIN

Managed Industrial Ethernet Switches Compact DIN Rail Switches Specifically designed to connect devices in network environments that are subject to extreme

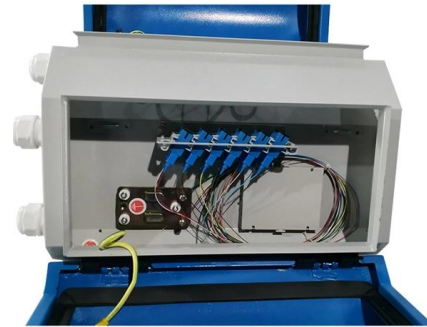

Industrial Ethernet Switches , Industrial Network Switch

Industrial-grade Ethernet Switches are specifically designed to connect devices in network environments that are subject to extreme operating temperatures of

What is the typical cost of industrial-grade switches?

The typical cost of an industrial PoE ethernet switch can range from \$100 to over \$5,000, depending on factors like port count, speed, PoE capabilities,



Enterprise Routers & Switches Cost Intelligence Report, 2030

Price of low-cost business-grade routers with strong VPN compatibility, improved security, and business application range from USD100 to USD200. Switch hardware typically costs between USD250 to



Industrial Ethernet Switches - Cost-Effective, Redundant Network

Our ECO switches are ideal for cost-sensitive applications that do not require technical features such as redundancy. They are ideal for small to medium-sized networks.

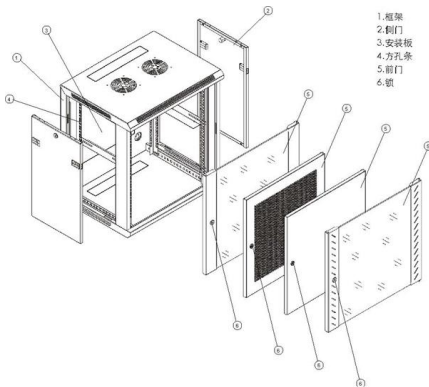

Industrial Ring Networks , ERPS , Antaira Technologies

Industrial Ethernet switches are critical components in network infrastructures, often used in harsh environments and mission-critical applications. The Ethernet Ring Protection Switching

Contact Us

For datasheets, pricing, or custom high-speed optical interconnect solutions, please visit:

<https://www.syropy.com.pl>