

# **Cost Standard for Level 3 Distribution Boxes**





## Overview

---

### What Is the Role of a PV Combiner Box in a Solar Array?

Solar energy systems rely on numerous interconnected components to efficiently convert sunlight into usable electricity. Type and Price: Smart Distribution Box>Explosion proof Distribution Box>Industrial Distribution Box>Residential Distribution Box The material of the distribution box, such as aluminum alloy, steel plate, plastic, etc. Your practical guide to smart power solutions for modern buildings Ever walked into a room and flipped a switch without thinking about what makes the lights come on?

That's the magic of a well-designed electrical system. Where Is the Distribution Box Located?

The d-box is typically buried 6-24 inches below the soil surface, positioned 5-15 feet from the septic tank outlet, directly in the path between the tank and the drain field. It sits close enough to the tank to receive effluent by gravity flow, but far enough.



## Cost Standard for Level 3 Distribution Boxes

---



### Comprehensive Guide on Costs to Replace Septic System D-Box

Explore the costs and factors involved in replacing a septic system distribution box, from materials to labor and permits.

### Electrical Distribution Boxes for Power Distribution

The goals of the appointment include the specification of the distribution box, the definition of the tender text and a cost estimate. But we will also talk about the

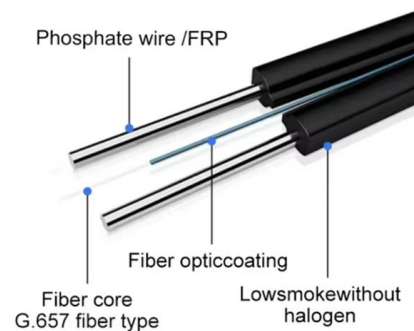

### How to choose high-quality industrial distribution boxes

First, you need to understand the requirements for boxes in your industrial production process. This includes the power, voltage level, current

### Essential Insights and Tips for Septic System Distribution Boxes

Introduction to Septic System Distribution Boxes  
Septic systems are a crucial component of wastewater management for homes and properties not connected to municipal sewer systems. At

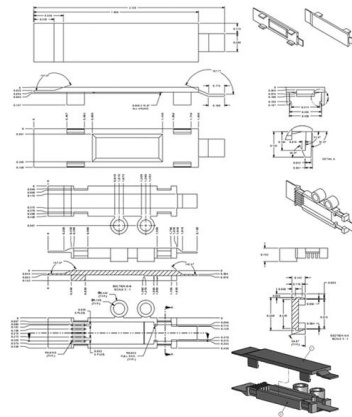

### Types and prices of distribution boxes in 2025\_COLORIA GROUP

While distribution box prices depend heavily on capacity and features, we've tracked emerging patterns. Expect these price points when budgeting for 2025 installations:

### Explore Distribution Boxes for Every Setting with Different Types

These codes may dictate specific requirements for distribution box size based on factors like building type, occupancy, and safety regulations. By considering these well-defined points, you

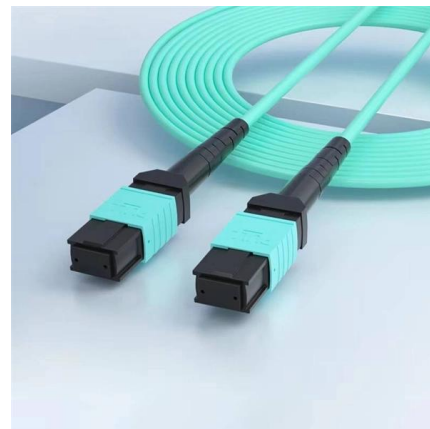

### Industrial 3 Phase Electrical Distribution Box Guide

Explore the essentials of industrial 3 Phase Electrical Distribution Box for efficient power management in commercial settings. Get expert insights now.



## Septic Tank Distribution: All You Need to Know about

1. What is a Distribution Box? A Distribution Box (D-Box) is a component of a septic system that collects wastewater from the septic tank and



### How to Choose the Right Distribution Box?

Find out how to choose the right distribution box for your needs! Learn about sizing, safety standards, essential features, and all factors.

### Quality Control for Installation and Construction of Electrical Riser

Quality Control for the Installation of Building Electrical Distribution Boxes Selection and Cost Estimation: Before installation, the quality of the distribution boxes must be carefully selected.



### Cost To Replace A Septic Tank Distribution Box -

The septic tank distribution box, or septic d-box, is a crucial component to your septic system. The average cost to replace the septic d-box is



## Analysis of the protection level test standard for distribution boxes

Distribution boxes protect our electrical systems like bodyguards shield VIPs. When they fail, everything goes dark. Today, we'll explore how international standards translate into practical

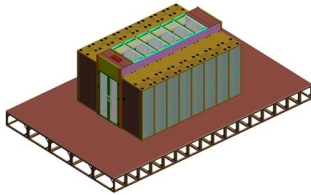
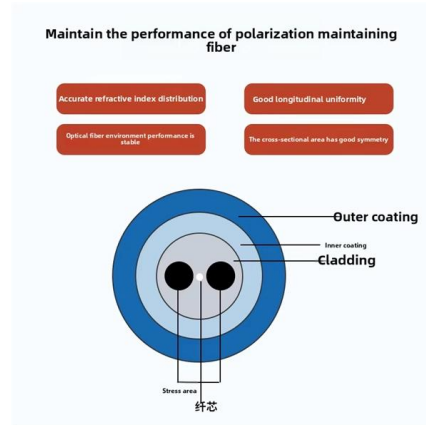

## Comprehensive Guide to Septic Tank Distribution Box Costs

Discover costs, factors, and tips for replacing your septic tank distribution box to ensure a reliable wastewater system.

## How to determine the price of the distribution box

So, how to estimate the price of the distribution box? The following article will provide you with step-by-step analysis and recommendations to make it easier for you to make a decision when making a

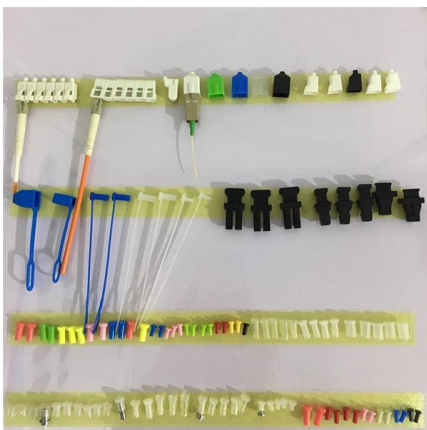

## Distribution Box Cost Guide 2024: Comprehensive Pricing, Features

Discover complete distribution box cost analysis including pricing factors, advanced features, safety benefits, and smart technology innovations. Get expert insights on ROI, installation costs, and long



## PASSIVE DISTRIBUTION BOXES

Exact12 distribution boxes for safety applications connect up to eight safe actuators in addition to eight standard sensors. They meet the EN ISO 13849-2 requirements.

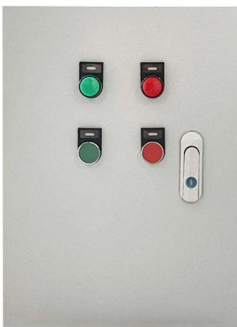

## Understanding Distribution Boxes: A Comprehensive Guide

A distribution box, also known as a power distribution box or electrical distribution box, is used to distribute electrical power safely to multiple

## What Is a Distribution Box? (2026 Guide) , SepticTankHub

Septic distribution box replacement typically costs \$500-\$2,000 installed, with most straightforward replacements falling in the \$600-\$1,200 range. The box itself costs \$80-\$400



## Septic Distribution Box Cost Guide 2026

The main cost drivers are the box itself, trenching or backfill, replacement or rerouting of laterals, and any required permits or inspections. The following sections break down price ranges,



Home

Hier sollte eine Beschreibung angezeigt werden, diese Seite lässt dies jedoch nicht zu.



### Explore Distribution Boxes for Every Setting with Different Types

Home » Blog 2 » Articles » Explore Distribution Boxes for Every Setting with Different Types, Prices and Factors Distribution boxes act as the central hub, receiving the main electrical



### Septic Distribution Box Cost and Pricing Guide 2026

The main cost drivers are the number of boxes, trenching, backfill, and permit requirements. Cost estimates below use typical U.S. pricing and assume standard residential soils



### How Much Is A Distribution Box A Complete Buyers Guide

The Price Landscape: Breaking Down the Costs When you start looking for a distribution box, you'll quickly realize the price range is wider than a highway. You might find a small plastic unit for the





## How Much Does Septic Distribution Box Replacement

The replacement cost of a septic distribution box can vary based on several factors, including labor, materials, and location. At the time of writing this



## ITPro Today, Network Computing, IoT World Today combine

ITPro Today, Network Computing and IoT World Today have combined with TechTarget . The page you are looking for may no longer exist.

## Comprehensive Guide to Septic Distribution Box Replacement Costs

Discover a detailed breakdown of septic distribution box replacement costs, including materials, labor, and hidden expenses.

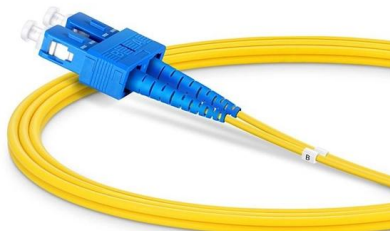

## TECHNICAL SPECIFICATION I.R.O. 63,100,160 & 315 KVA

3. SYSTEM DETAILS: Distribution Boxes are meant for control and protection of Distribution Transformers with relevant parameters as under:-



## Septic Distribution Box Cost and Pricing Guide 2026

Homeowners typically spend several hundred to several thousand dollars for distribution box work in septic systems, depending on system size, material, and installation complexity. The



## Contact Us

---

For datasheets, pricing, or custom high-speed optical interconnect solutions, please visit:

<https://www.syropy.com.pl>