

# **Construction Engineering Cable Tray**





## Construction Engineering Cable Tray

---

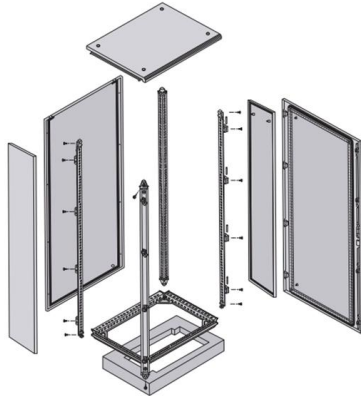

### dayu-stainless-steel-cable-tray-factory

32 Companies and suppliers for dayu-stainless-steel-cable-tray-factory Find wholesalers and contact them directly Leading B2B marketplace Find companies now!

### Best practice guide to cable ladder and cable tray

Cable ladder and cable tray systems The following recommendations are intended to be a practical guide to ensure the safe and proper installation of



### The Comprehensive Guide to Cable Tray Systems:

Master cable tray systems with our expert guide covering structural engineering, material selection, and NEC compliance to ensure safe, efficient,

### Buy Cable Management Trays & Wire Baskets , Fast Delivery

Browse our range of cable trays below! We offer cable trays that are perfect for a variety of applications. Our products are made of high quality materials and come with free delivery on orders over £100.



### **cable tray solutions For tunnels guide**

The Legrand cable tray ranges not only perform their initial function, to support conductors, but their specific accessories enable them to take additional equipment: luminaires, signs, emergency lighting,

### **Senior Electrical Construction Engineer - (Cable Tray)**

HNC in relevant construction discipline or electrical engineering and extensive experience working in this type of role A good working knowledge of electrical cable containment and earthing



### **Guide to cable support systems**

Four different mesh cable tray types are available, depending on the requirements, area of application and cable quantity. The innovative Magic connection system of the GRM and G-GRM mesh cable



## CABLE MANAGEMENT SYSTEMS CABLE TRAYS & ACCESSORIES

We manufacture a wide range of products capable of providing the characteristics which respond to the proposed application, along with quality of assembly, speed of installation, and cost-saving cable trays.

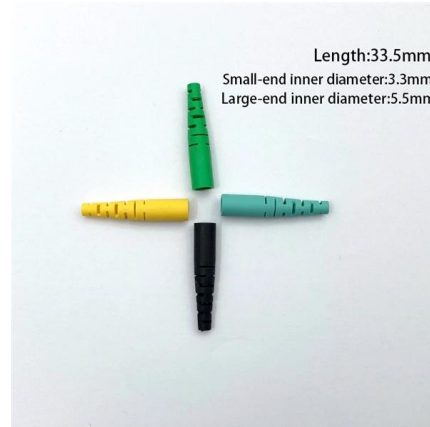

### B-Line series Cable Tray Design Considerations

Cable tray (or cable ladder) systems are a popular alternative to electrical conduit systems, as they have an outstanding record for dependable service, design flexibility and cost savings in commercial and

### Codes and Standards , Cable Tray Institute

The Cable Tray Institute is making available the current edition of this practical guide for the proper installation of aluminum or steel cable tray systems. These guidelines will be useful to engineers,



### A Guide to Selecting Cable Trays for Engineering Design

Learn about the essential factors when selecting cable trays for engineering design. Understand load calculations, safety factors, material choice,



## Guide to cable support systems

Universal systems for cable support structures are used for small loads. The systems are suspended from the ceiling with threaded rods, stand-off brackets allow raised floor mounting of cable trays,

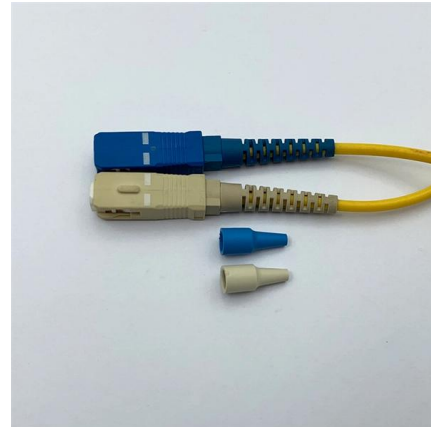

## What Is A Cable Tray? 5 Types Of Cable Trays

A cable tray is a structural system used to support and manage electrical cables in various settings, such as industrial, commercial, and residential environments.

## Senior Electrical Construction Engineer - (Cable Tray)

HNC in relevant construction discipline or electrical engineering and extensive experience working in this type of role A good working knowledge of electrical cable containment and earthing installations.

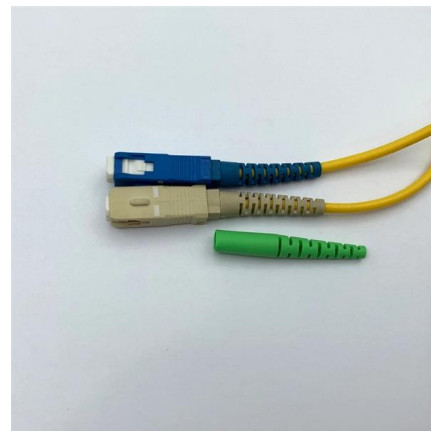

## Types of Cable Trays: Ladder, Perforated, Basket, Solid

Explore all types of cable trays--ladder, perforated, basket, solid, and channel. Learn their uses, materials, pros, cons, and key differences.



## Senior Electrical Construction Engineer

HNC in relevant construction discipline or electrical engineering and extensive experience working in this type of role A good working knowledge of electrical cable containment and earthing installations.

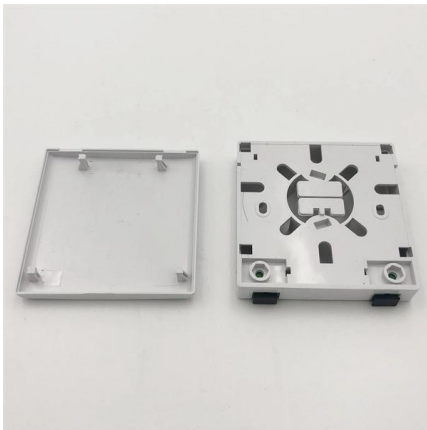

## How to Install Cable Tray: A Comprehensive Guide to Different Cable

Welcome to our step-by-step guide on installing cable trays! In this video, we'll explore the different types of cable trays available and provide detailed instructions for their installation.

## Cable Tray Technical Guide A practical guide to product selection and

This guide for engineers and installers has been developed by ABB as a practical reference regarding cable tray characteristics, installation, and requirements.

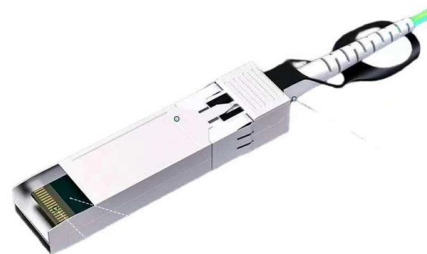

## 100+ Essential Questions Answered About Cable Trays:

Discover over 100 expert answers about cable trays, covering key topics like material selection, load capacity, installation methods, and maintenance.



## Dayu stainless steel cable tray factory Germany

Automated steel from WDI - precise quality steel for mechanical engineering, automotive & automated manufacturing Spannstahtlitze by WDI - High-strength steel cables for construction, bridge structures



## Best Practice Guide to Cable Ladder and Cable Tray Systems

This guide covers cable ladder systems, cable tray systems, channel support systems and associated supports intended for the support and accommodation of cables and possibly other electrical

### Annex I

This document deals with cables trays, cables and connector installation and segregation, cable trays earthing and E.M.C. directives. These rules shall be applied in the cabling engineering workflow for



### Cable tray

In the electrical wiring of buildings, a cable tray system is used to support insulated electrical cables used for power distribution, control, and communication. Cable

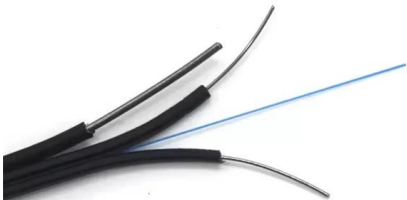



## Complete cable tray manual for electrical engineers and

Complete cable tray manual for electrical engineers and designers (on photo: power cable management ladder tray systems assembled aluminum cable tray ladder

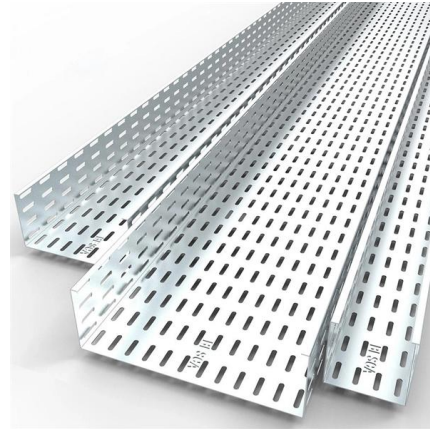

## Contact Us

---

For datasheets, pricing, or custom high-speed optical interconnect solutions, please visit:  
<https://www.syropy.com.pl>