

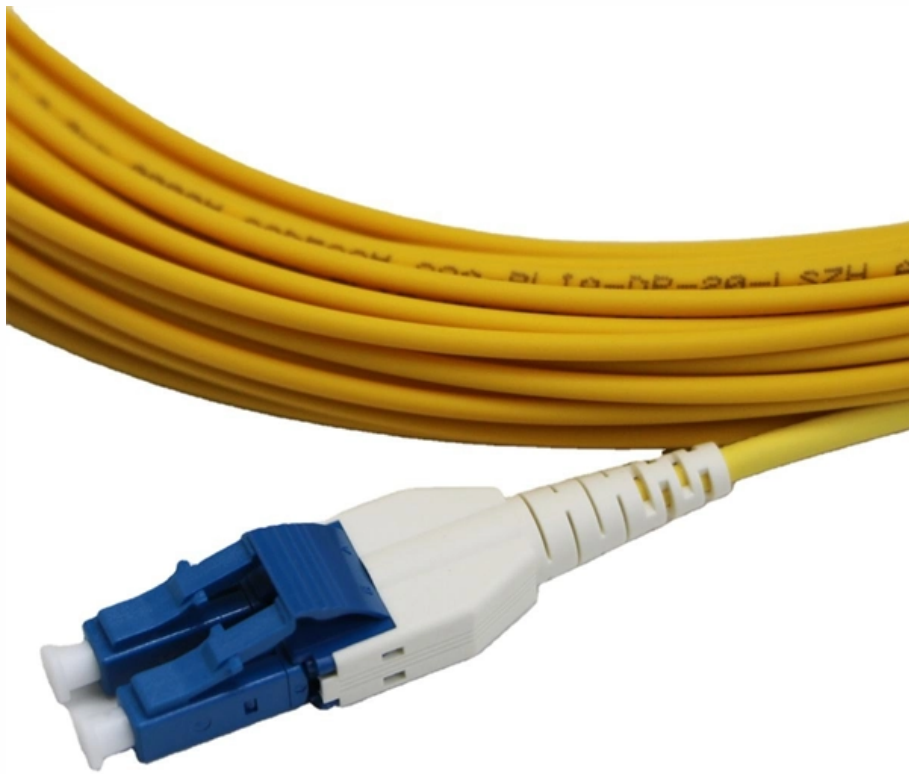

**Syropy AI Connectivity**

# **Chilean OEM Aggregation Switch NRZ**





## Chilean OEM Aggregation Switch NRZ

---



### Aggregation Switch: Increasing the Priority of Special Traffic

The traffic policy is applied successfully, and packets sent by the special user (PC1) leave the aggregation switch through queue 5 on the outbound interface (uplink interface of the aggregation)

### Aggregation Network Switches , Grandstream Networks

These aggregation switches support advanced VLAN for flexible traffic segmentation, advanced QoS for prioritizing network traffic, IGMP/MLD Snooping for optimizing

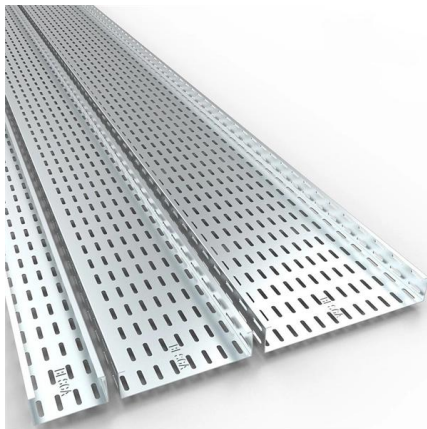

### Aggregation Switches: LANCOM Systems GmbH

LANCOM aggregation switches enable high-performance and hierarchical switch infrastructures to be set up and serve as the distribution basis for networking

### Ubiquiti USW-AGGREGATION Switch UniFi 8-SFP+10G

Gestión avanzada: Como un switch administrado, permite configuraciones y monitoreo a través de la interfaz de UniFi, facilitando la administración de la red y



### What is an Aggregation Switch? , Features and Practical Benefits

This article focuses on the question of what is an aggregation switch and how it works its uses and its implementation. Read till the end to learn this very important concept in network



### Compact Load Break Switches in Chile , CNC Electric

Chile's energy landscape is undergoing a rapid transformation. With a booming renewable energy sector (accounting for 30% of national electricity generation in 2025) and ongoing upgrades to its aging grid,

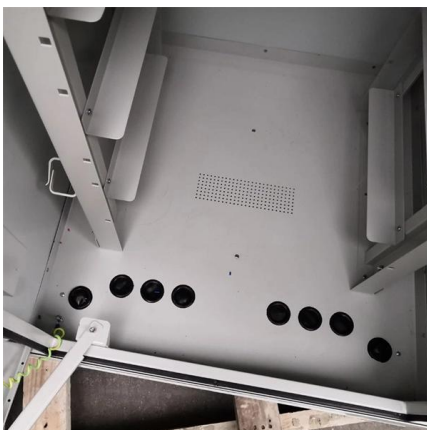

### Buy Aggregation Switches for High Traffic

Shop new & used aggregation switches for high-traffic network environments, ensuring robust connectivity and efficient data handling.



## NRZ vs PAM4 Understanding the Key Differences

PAM4 vs NRZ: Compare data rates, noise tolerance, and efficiency to choose the best modulation for your network and data center upgrades.



## Aggregation Switches: LANCOM Systems GmbH

Für Switch-Architekturen mit 100% Uptime sorgen Funktionen wie Virtual Port Channel (VPC / MC-LAG) sowie ein wählbares Lüfterkonzept und redundante

## Ericsson, Entel Chile Demonstrate 250 Mbps Carrier Aggregation with

Stretching the communications envelope, Ericsson and Entel Chile have announced the successful demonstration of an end-to-end LTE-Advanced (LTE-A) Carrier Aggregation (CA) solution



## Configuring Aggregation and Access Switches to Be Managed by the

On the core switch, configure a management subnet for aggregation and access switches, enable the DHCP server function on the gateway interface of the subnet, and enable the controller address auto



### Aggregation Switch

An Aggregation or "Top-of-Rack" switch is designed to connect everything in a rack at high speeds, then have an even bigger pipe out to the rest of the network.



### Aggregation , TP-Link Chile

Con funciones avanzadas como enrutamiento estático, servidor DHCP, listas de control de acceso (ACL) IGMP Snooping, STP, LAG y administración centralizada en la nube, representan una solución

### Global Aggregation Switches Market 2024 by Manufacturers,

Regionally, the report analyzes the Aggregation Switches markets in key regions. North America and Europe are experiencing steady growth, driven by government initiatives and increasing consumer



### Acquisition of the Mulpun ISG Project in Chile

About the Mulpun Project Location The Mulpun site is located in southern central Chile, 840 km south of Santiago and 40 km east of Valdivia, a city with a population of 150,000. The project





## Aggregation switches and routers

The expected growth of gigabit and multigigabit services requires operators to architect network access scalability upfront. For this reason, we have delivered a



### OEM Aggregation Switch Factory, Manufacturer

The Aggregation Switch offered by Sichuan Hasivo Electronics Co., Ltd. is a high-performance networking device designed to efficiently handle data traffic in large-scale networks. This switch is

## Aggregation

El USW-Aggregation de Ubiquiti es un interruptor de red de alto rendimiento, diseñado para manejar grandes volúmenes de datos en entornos exigentes. Con 8 puertos SFP+ de 10G, este switch

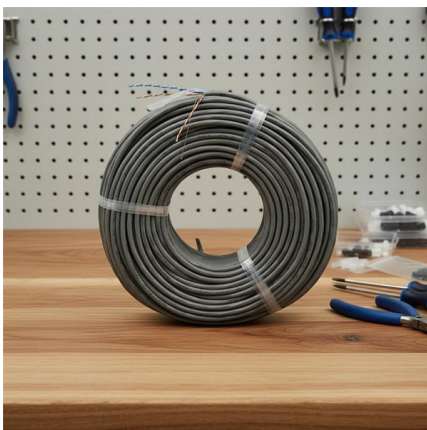

### Key Technologies

This document examines key technologies used in constructing LinkX cables and transceivers for 100G-PAM4, 50G-PAM4, and 25G-NRZ -modulation based interconnects used to



## Hi-Capacity Aggregation

El Ubiquiti Hi-Capacity Aggregation ( USW-Pro-Aggregation) es un switch de capa 3 de alta capacidad, diseñado para redes empresariales avanzadas que requieren



## Aggregation , TP-Link Chile

TP Link - Aggregation Equipados con puertos totalmente de fibra, los switches de la serie Aggregation ofrecen velocidades de hasta 10 Gbps. Con funciones avanzadas como enrutamiento estático,

## Switch Aggregation

An 8-port, Layer 2 switch made for 10G SFP+ connections.

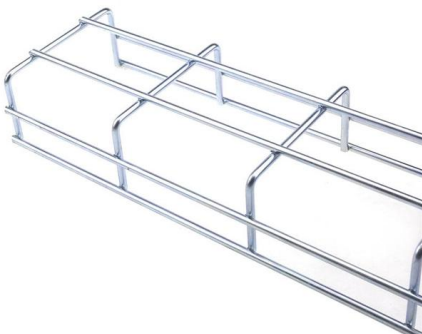

## Switch Ubiquiti USW-AGGREGATION

Switch Ubiquiti USW-AGGREGATION - 8xSFP+ 10G, 160Gbps, Rack 1U, Admin L2 Part number: USW-AGGREGATION / Cod: NA0000079472 UBIQUITI Pago con



## Everything You Need to Know About Aggregation Switch

A: Ubiquiti UniFi is a brand of networking equipment, including aggregation switches, that offers high-performance and easy-to-manage solutions

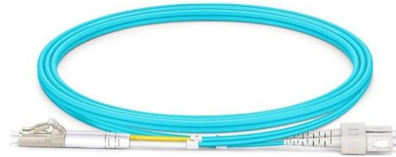

## What Is an Aggregation Switch and How to Choose?

An aggregation switch is a network device that consolidates traffic from multiple access switches, wireless access points, or other edge devices and forwards it to

## Ubiquiti USW-Aggregation, Switch de Agregación L2, 8 Puertos

El Ubiquiti USW-Aggregation es un switch de capa 2 con 8 puertos 10G SFP+, ideal para la agregación de tráfico en redes de alto rendimiento. Perfecto para entornos que requieren gestión eficiente de

Focus creates quality products



## 50G PAM4 Technical White Paper

An NRZ signal is a 2-order signal with an eye diagram of a single eye, whereas a PAM4 signal is a 4-order signal with an eye diagram of three eyes. Although PAM4 doubles the bit bearing efficiency



## What Is an Aggregation Switch and How to Choose?

As the physical part of the aggregation layer, aggregation switches typically play a crucial part in the overall network architecture. So, what exactly is an aggregation

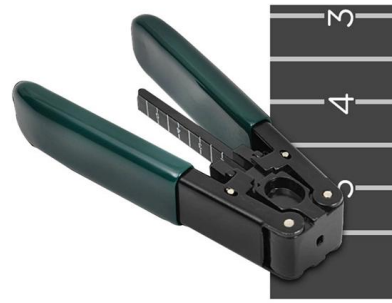

### Huawei

We're sorry but web site doesn't work properly without JavaScript enabled. Please enable it to continue. Loading

### Switch Hi-Capacity Aggregation

A 32-port, Layer 3 switch made for high-capacity 10G SFP+ and 25G SFP28 connections.

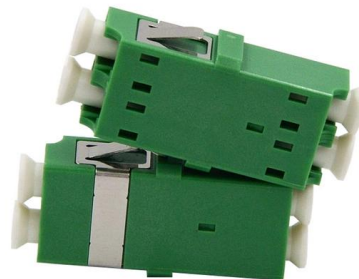

## Contact Us

---

For datasheets, pricing, or custom high-speed optical interconnect solutions, please visit:  
<https://www.syropy.com.pl>