

Cable reel unloaded from distribution box

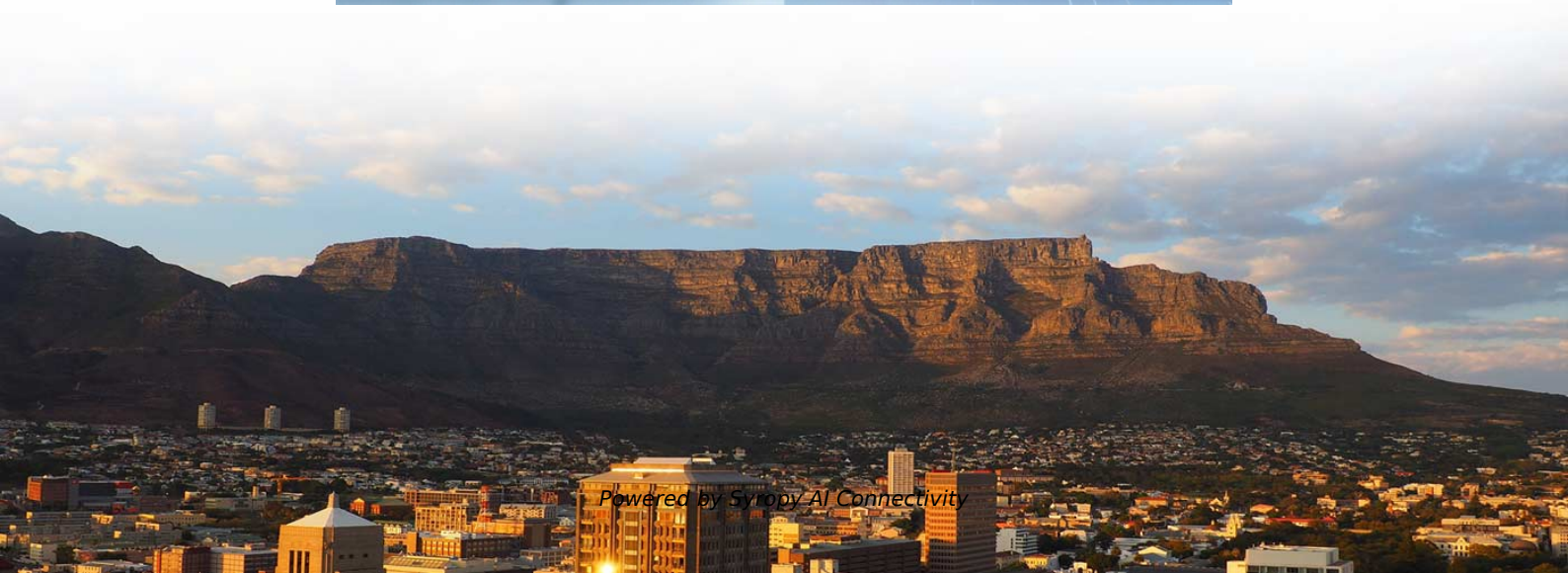



Overview

If unloading the cable drums with a crane an axle must be used to avoid lateral pressure on the flanges. Brief video tutorial on loading and unloading operations and precautions for the handling of iron or wooden reels on the installation sites. When pulling cable in duct, use breakaway swivel rated 600 lb, not applicable to MiniXtend. Do not attempt to lift drums of cable without inserting the fork lift tynes fully under both flanges as the tynes can damage the cable, making it unserviceable.



Cable reel unloaded from distribution box

HANDLING AND IRANSPORTING LARGE LAND CABLE REELS



1.05 Wire armoured reels are "submarine" cable reels and are excluded from this section. Armoured and other special protective covered cables may occasionally be shipped on land reels, but the weight of

Wire and Cable Handling , BHS

Wire & Cable Handling Wire and Cable Handling, Cable Management, and Reel Handling Solutions At every step along the electrical supply chain, users must handle cable, wire, and other spooled

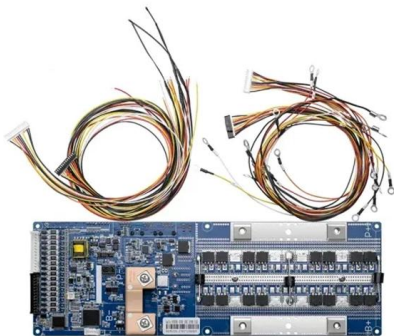
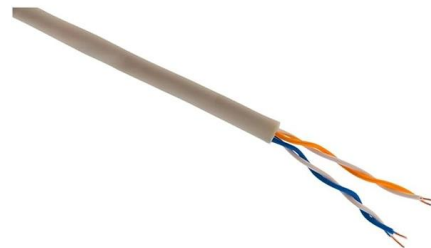

Guidelines for cable drum handling during transport and storage

After unloading the cable drums at the destination, employees may roll the reels by hand (if necessary). Here, the rolling motion may be controlled at all times so that a rolling or tipping of the drums is

GENERAL INFORMATION

Cable reels unloaded down ramps should be rolled in a controlled manner. The ramps must be of a gradual incline, spaced parallel and wide enough to ensure contact at all times with both reel flanges



Focus creates quality products



Cable Reels: Principles and Applications , IQS Directory

Analyze the applications and benefits of cable reels. Peruse the various types of cable reels, like wooden, plastic, steel, and spring cable reels.

INSTRUCTIONS FOR CABLE STORAGE & HANDLING

Cable Reel Handling Handling of Cable Reels
When moving cable reels, care should be taken to insure that material handling equipment does not come in contact with cable surfaces or with protective



Handle with Care: The 6 Do's and Don'ts of Cable Reels

Proper reel handling creates a safe working environment, simplifies installation, and improves the reel's usable lifespan.



RECEIVING, HANDLING, AND STORING CABLE

Receiving and Handling Cable In order to benefit from investing in underground cable (power cable), the purchaser should put into practice a complete visual inspection program that will help identify any



J Harlen Co.

Utility Tool & Trailer designed the LD Payout Reel for both picking up wire cable in neat coils in addition to paying out. Unit expands and contracts and is designed to

How to Install a Cable Distribution Box Safely and

In modern electrical systems, cable distribution boxes (also known as electrical distribution boxes or distribution boxes) play a crucial role as the key

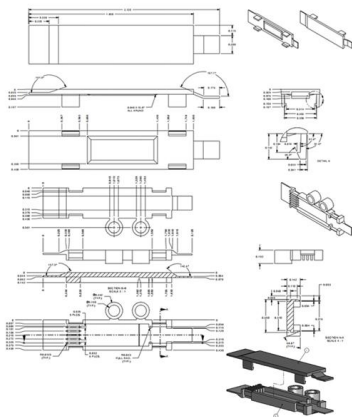

Cable Handling, Storage and Installation Guide

When using a crane or other overhead lifting device to move reels, insert a steel lifting bar in the reel arbor hole and use a lifting yoke or spreader bar to prevent (1) damage to the reel flanges and (2)



Helpful tip for Cable Pulling with Reels

This makes pulling cable from Reels so much easier and it's very simple to set up. Phone or Data Cable usually comes in either a Pull Box or a Reel (spool). I prefer reels because they have more



Cable Reel Loading and Unloading Safety

The Job Safety Analysis document outlines safety procedures for unloading, loading, and placing cable reels. Key steps include mobilizing equipment, preparing tools

Anixter: Cable handling do's and don'ts , Cabling

Generally speaking, in terms of fundamental cable handling best practices, the distributor notes that cable reels should be stored indoors on a hard, dry surface.



How to load and unload iron or wooden reels and handling on site

Brief video tutorial on loading and unloading operations and precautions for the handling of iron or wooden reels on the installation sites.



Premise Cable

Box v Reel - twisting? I've just completed a job pulling CAT 5e into a 150,000 sq ft warehouse/HQ office remodel for the previous occupant. The cable trays we already used and some



Cable Placing Checklist and Handling: Squirting, Tangling

This Applications Engineering Note (AE Note) addresses common issues regarding cable pay-off during outside plant installations known as cable squirting, cable tangling during payoff, and



Cable Placing Checklist and Handling: Squirting, Tangling

AEN165, Revision 5 This Applications Engineering Note (AE Note) addresses common issues regarding cable pay-off during outside plant installations known as cable squirting, cable



Technical Information Instrumentation, Power & Control

Under no circumstances should reels be dropped from the delivering vehicle to the ground. Unloading and reel handling should be accomplished so that the equipment used does not contact the cable



Guidelines for cable drum handling during transport and storage

delivery Cable drums with a size of 400 mm to 1600 mm are supplied, stacked and strapped with steel bands, so that in packages combined drums can be unloaded quickly and safely. From a drum size

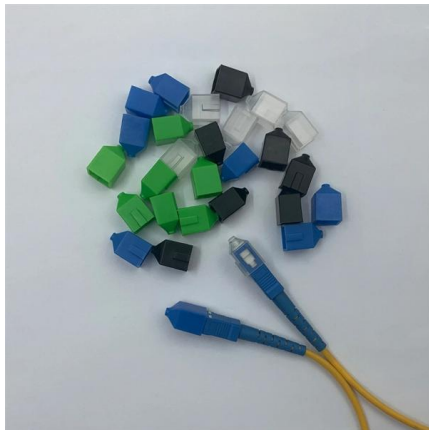

Handling Installation Rev 21 , PDF , Electric Current , Cable

The document provides guidance on properly handling, receiving, inspecting, storing, and installing underground power cables. Key steps include visually inspecting

Loaded Cable Reels and Unloading off Stepdeck

My first reel load. I show how we secured the reels using chains and straps as well as the unloading view. Long haul load from Georgia to Houston and Fontana. Trucking, trucker, flatbed, stepdeck



Wire Cable Handling and Installation Engineering Guide

Receipt of Cable Reels Once the purchaser has received the cable shipments, they should carry out an approval inspection. A cable approval inspection involves some straightforward and low-cost steps



General Unloading, Handling & Storing of Steel & Wooden Reels

In this method, the drum/reels are lifted out of the container by a forklift where drum/reel side will be facing outward as illustrated in the photo below. The drum/reels are secured in the container using

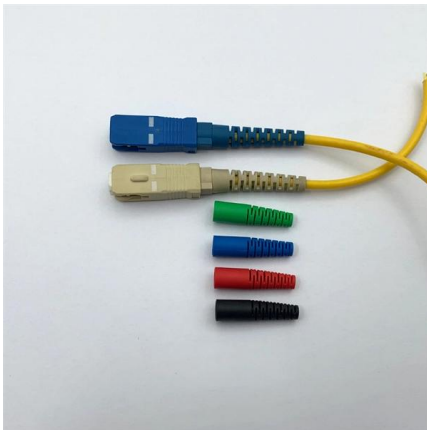

News

Unloading cable reels at a construction site or any other location requires careful attention to safety. Here are the safest methods for unloading cable reels, referencing information from two sources.

Which Package To Choose? Box Or Reel? , LAN Cable

The criteria to decide LAN cable's package type is usually affected by usage habits and environmental factors. Which one is better, then?

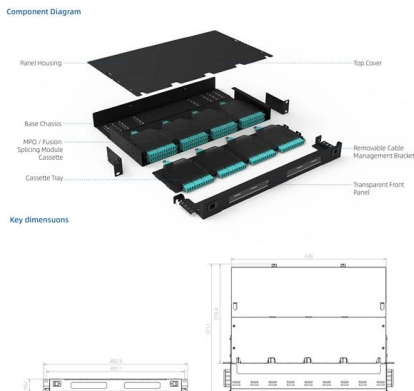

Cable Handling & Storage Guideline Information

While unloading the cables certain precautions are to be taken to ensure the safety of the cables. The cable drums should not be dropped or thrown from rail way



TRANSPORT, HANDLING AND STORAGE PROCEDURES FOR

Do not roll cable drums from the back of a delivery truck to the ground as the resulting flange damage will be unacceptable to the customer as the cable will not be able to be rolled off the drum and the



Contact Us

For datasheets, pricing, or custom high-speed optical interconnect solutions, please visit:
<https://www.syropy.com.pl>