

# Ampere meter test of distribution box wiring

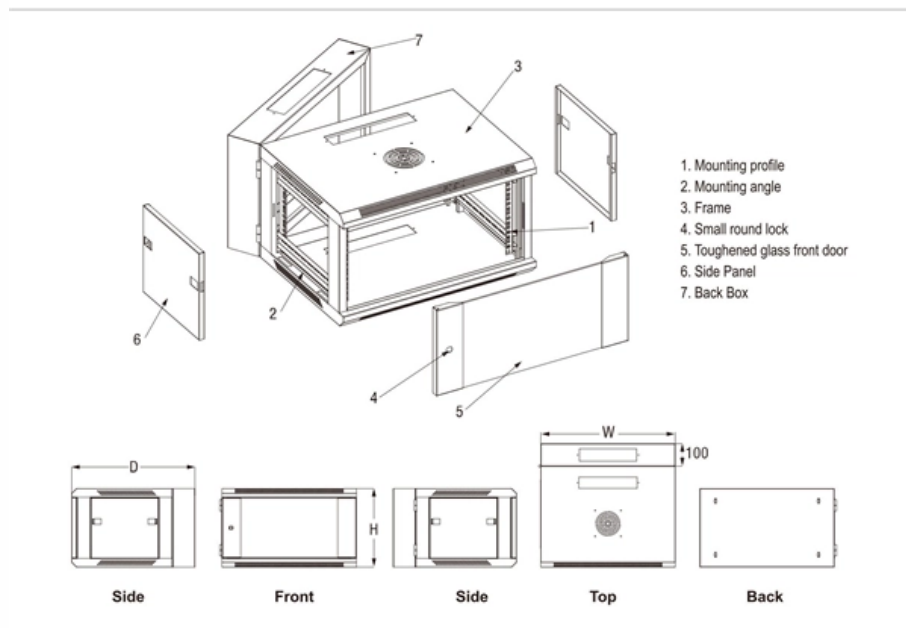



## Ampere meter test of distribution box wiring

---



### Wiring Diagram for Electric Meter Box

Learn how to wire an electric meter box with a detailed wiring diagram. Follow step-by-step instructions to ensure a safe and efficient installation.

### How to Use an Ammeter: 10 Steps (with Pictures)

Current is the measure of the flow of electricity through a circuit in amperes (amps) by a device known as an ammeter. You can check amperage



### 3 Ways to Connect an Ammeter

Connect the red lead to the A port on the ammeter. Note the ports carefully since some devices may have multiple ones. The ampere port, labeled

### Distribution Board Wiring Diagram For Single Phase Wiring

Single Pole MCB Breaker  
Electrical Cables  
Electrical Connectors  
Earth Connection  
Ampere Meter and Ct Coil  
The Ampere meter is very important in the distribution board because this device showed the total current



(Ampere) getting the complete circuit or a load of the complete circuit. I have shown in the above diagram, how to wire an ammeter with CT current transformer, however, for better understanding visit the below link. See more on [electricalonline4u electricaltopic](http://electricalonline4u.com/electricaltopic)

## Digital Ampere (Ammeter) meter: Types, diagram

Ampere meter is an electrical measuring instrument device which is used for current (power) measuring in electrical circuit or equipments is available in market as



## The installation requirements for the distribution box

Learn how to install a distribution box safely and correctly. Covers wiring, placement, standards, and expert tips for a compliant setup.

## How To Wire & Install a 1-Phase kWh Energy Meter?

Installation of 1-Phase Energy Meter , 1-?, 2-Wires Electric Meter for 230V & 120V/240V AC Mains Supply & Service (From the Power Supply to The Main



## How To Wire & Install a 3-Phase kWh Energy Meter?

Three Phase Meter Wiring for 400V AC - (UK & EU) - IEC In UK, EU, Asia and IEC following countries, the three phase supply of 400V AC is provided by four wires



### Connecting the Meter to the Breaker Box: A Guide to

Learn about the important wire connection between the meter and breaker box for electrical systems. Ensure a safe and efficient power distribution.



### How To Test Electrical Wires With A Multimeter? A Complete Guide

This detailed guide will walk you through the essential techniques for testing electrical wires using a multimeter, empowering you to perform basic electrical checks safely and confidently.

### Electric Panel Installation Method Statement , PDF

This document provides a method statement for installing and terminating electric panels and distribution boxes. It outlines 4 steps: 1) Pre-installation preparation

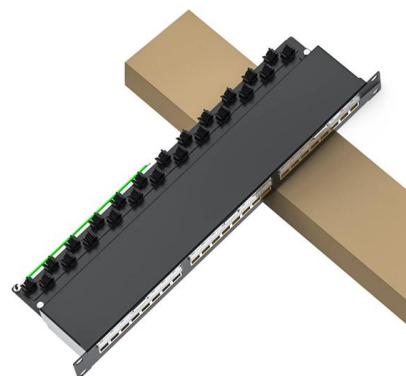

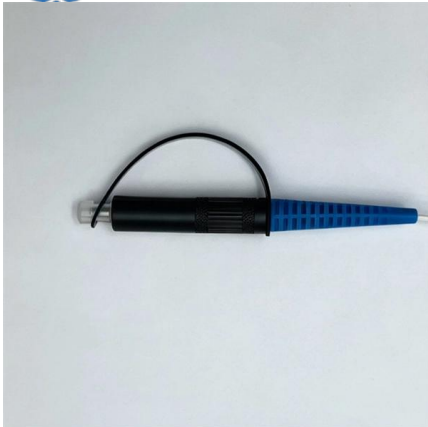

### How to test a three-phase distribution box by using a

The distribution box testing is very important and before doing this test we need to check the megger or insulation tester. In the merger we can see a

### Wiring of the Distribution Board From Energy Meter to

How to Wire a Distribution Board? Distribution Board aslo known as "Panel Board", "Switch & Fuse Board" or "Consumer Unit" is a box installed in the building

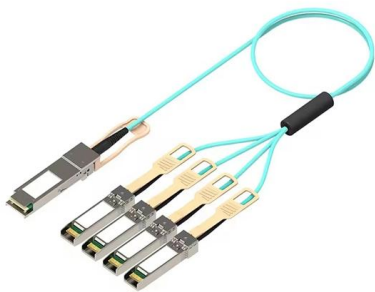

### The Complete Guide to Electrical Insulation Testing

If the apparatus you are testing has very small capacitance, such as a short run of house wiring, the spot reading test is all that is necessary. However, most equipment is capacitive and so your very first

### Wiring Diagram for Electric Meter Box

Final Thoughts on Electric Meter Box Wiring Properly wiring an electric meter box is crucial for ensuring the safe and reliable distribution of electricity throughout a





## Electric Meter Inspection, Reading, Problem Diagnosis + how to

Detailed procedures for electrical inspection, testing, diagnosis, and loss prevention, with links to critical safety information for electrical inspectors and electricians. Evidence of electrical arcing or burning at

## Main Sub-Main Distribution Boards Testing and

Method Statement For The Testing and Commissioning of Main Sub-Main Distribution Boards (MSMDB) Sub-Main Distribution Boards (SMDB) Distribution

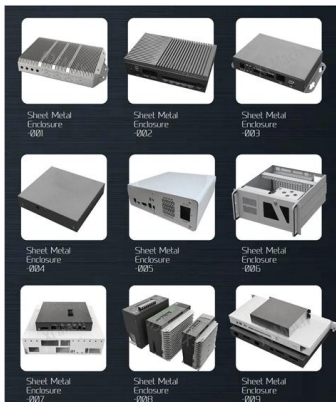

## Electrical Wiring At The Meter Box (DIY Version).

A meter box or board wiring is easy for DIY electrician pros. It is the link between the power grid and your home electrical system. Top Heights Electricals

## Inspecting the Main Electrical Panelboard During a

Type SE, Style SEU service-entrance cable is primarily used to convey power from the service drop to the meter base and from the meter base to the distribution



## How to Inspect a Residential Electrical



### Distribution Panel

How to Inspect Electrical Panels, list of defects, safety hazards, safety for the inspector. Electrical panel inspection procedures: How to inspect electrical panels - the main panel Inspecting the electrical



### Residential Electric Meter Box Wiring Diagram Guide

Clear wiring diagram for residential electric meter box, showing connections, safety components, and layout for accurate installation and maintenance.

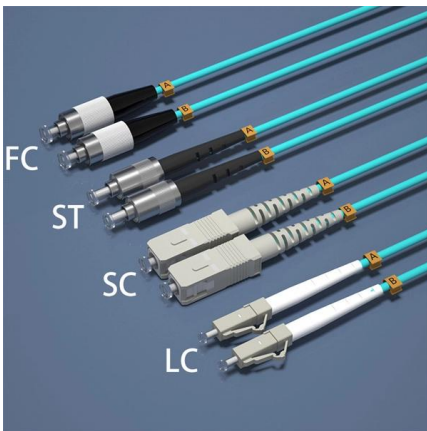

### How to Wire 120/240V Main Panel

120/240V Main Panel Breaker Box How to Wire 120V Circuits & Breakers The following tutorial explains how to wire a 120V single-phase breaker and load

### How To Test A Breaker Box With A Multimeter? Troubleshooting Guide

The electrical breaker box, also known as a distribution panel or load center, is the heart of your home's electrical system. It's the central point where electricity enters your house and is





### Single phase energy meter wiring from pole to Distribution box

In this i have shown how to do a wiring of energy meter from utility pole or electric pole to distribution box with accl . ACCL is use for switching the supply between transformer and DG .

### How do I run a wire from the meter to my breaker box?

This article provides a step-by-step guide to connecting meter wires to circuit breaker boxes including tools needed power-off prep wiring grounding inspection and key safety tips



### Demystifying AMP Testing: A Step-by-Step Tutorial Using a Multimeter

Testing the amperage of an electrical circuit is a crucial step in electrical troubleshooting and maintenance. Using a multimeter, a versatile measuring device, you can accurately determine

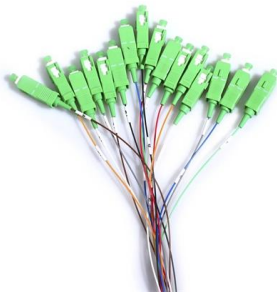

### The Complete Guide to Wiring Diagrams: From Meter to

Learn how to read and understand a wiring diagram from the electric meter to the breaker box in order to troubleshoot and fix electrical problems in your home. Get





### **Method Statement for Installation & Testing of Electrical**

This method statement will help the electrical engineers and supervisors for the installation of distribution board for an electrical project. Additionally site team will

### **full Wiring of the Distribution Board From Energy Meter to**

This video shows the full Wiring of the Distribution Board From the Energy Meter to the Consumer Unit. Distribution Board also known as a "Panel Board", "Switch & Fuse Board" or



## **Contact Us**

---

For datasheets, pricing, or custom high-speed optical interconnect solutions, please visit:  
<https://www.syropy.com.pl>