

After-sales service access switch DML

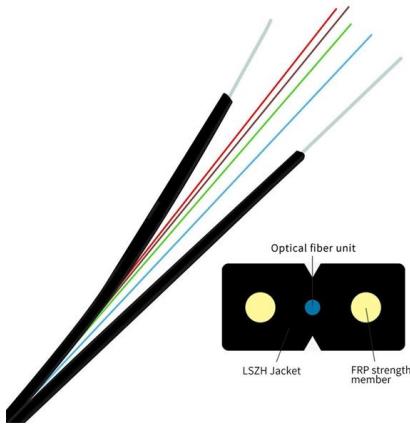



After-sales service access switch DML



Why aftermarket and service are vital to OEMs--and how to excel

In rail, a major rolling stock OEM leveraged its digitally-enabled aftermarket service platform to reduce unscheduled maintenance while improving availability.

Data Manipulation Language (DML) in Salesforce Apex

Learn about Data Manipulation Language (DML) in Salesforce Apex, different operations, their syntax & how to use them in Apex class and execute



DML Operations , Apex Developer Guide , Salesforce Developers

DML Operations Using DML, you can insert new records and commit them to the database. You can also update the field values of existing records.

After-Sales Service Management: Streamline Dealer

Regular servicing is one of the most critical forms of after-sales support. From oil changes and brake checks to multi-point inspections, a DMS



DISTRIBUTED PV GENERATION + ESS

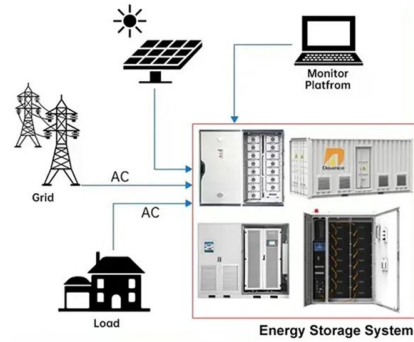

Salesforce/apex-dml-operations.md at master

You can perform DML operations using the Apex DML statements or the methods of the Database class. Make the insert not fail if one record fails
List accounts = new List (); // Populate the accounts list //

After sales service documentation , Siemens

Growing vehicle complexity due to the rise of advanced driver assistance systems (ADAS) and autonomous vehicle (AV) technologies is creating new challenges for technical authoring and after

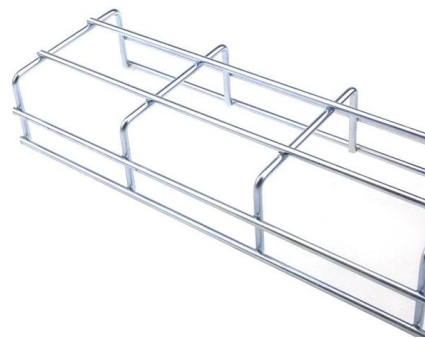

What Is After-Sales Service? 7 Types and Benefits

Understand the role of after-sales service in modern businesses, its impact on customer retention, and discover practical tips to elevate your



After-sales service solutions , TeamViewer

Manage your after-sales service in one central environment with direct ticketing system integration and the ability to switch from chat to call to video, all in the same application.

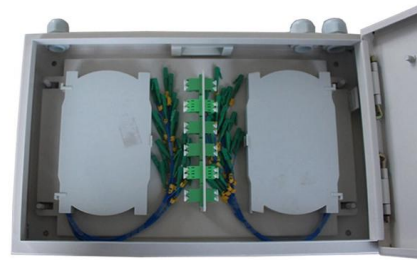

After-Sales Service

In this post, I am shedding a light on some of the capabilities and features of the service module which is specifically related to selling items and after-sales services.



What is DML?

DML vs DDL As seen above, DML stands for Data Manipulation Language and it is used to manipulate data. DDL on the other hand, stands for Data Definition Language, and it is used to



Axway Mapping Services DML Getting Started Guide

Example FoodBroker projects are delivered within the Axway Mapping Services in the directory Exercises. You can use these projects as a basis for your tests and to become





AWS DMS key troubleshooting metrics and performance

In this post, we discuss AWS Database Migration Service (AWS DMS) and how you can use Amazon CloudWatch and logs to monitor the

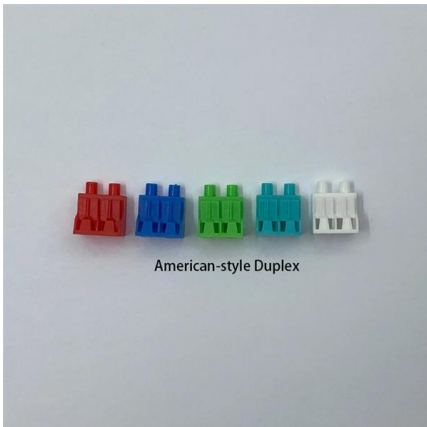

After-Sales Service Network Solutions , Excellon Software

Efficiently manage after-sales service across distributors, dealers, and third-party providers through a unified system that streamlines claims, tracks spare parts,

Adding and Retrieving Data With DML

Also, you can use DML to modify records that have already been inserted. Among the operations you can perform are record updates, deletions, restoring records from the Recycle Bin, merging records,



Access to digital car data and competition in aftersales services

These scenarios may offer some scope for regulators if they wish to keep alternative data access channels open in order to stimulate competition in aftersales services markets. However, they entail



About DML Statements and Transactions

About Data Manipulation Language (DML) Statements Data manipulation language (DML) statements access and manipulate data in existing tables. In the SQL*Plus environment, you can enter a DML

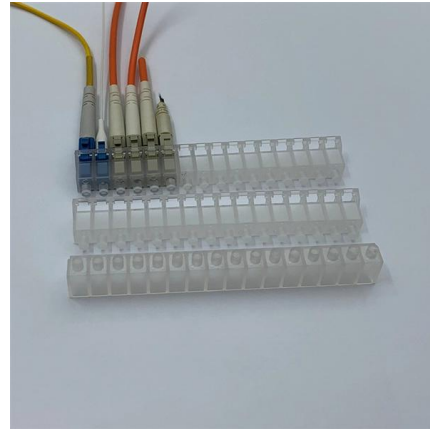

DML Statement vs. Database methods in Salesforce

As a Salesforce application developer, we always have a question like how many ways we can perform the DML operations when dealing with

Enhancing After-Sales Service with a Dealer

Enhance your dealership's after-sales service with QCS's Dealer Management System. Discover how ERPNext can transform your operations today!



7 Best After-Sales Service Management Software for OEMs in 2026

In this article, we will compare the seven best after-sales service management software and highlight the features that drive recurring revenue and protect service margins for original equipment



In-Depth Guide to Database Manipulation Language

Database Manipulation Language (DML) operations in Apex are fundamental for interacting with data within Salesforce. Apex, being a strongly



Health.mil

Hier sollte eine Beschreibung angezeigt werden, diese Seite lässt dies jedoch nicht zu.

DML Instructions

Where to use DML Instructions Each DML Instruction is only appropriate in one or more predefined contexts. For example, a given DML instruction may only be applicable to a Map or a Validation

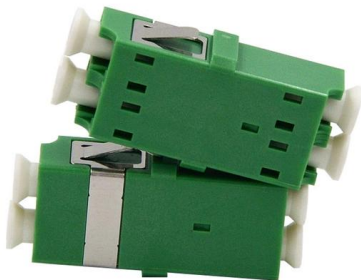

XENTRY Portal

XENTRY Portal provides access to Mercedes-Benz after-sales services and solutions for workshops and professionals.



What is Data Manipulation Language: Definition , Types , Example

Learn Data Manipulation Language (DML), its types, and SQL commands with examples to insert, update, or delete data in a database.



Data Manipulation Language (DML): A Practical Guide

Unlock the potential of Data Manipulation Language(DML) with our step-by-step guide. Learn how to manage and optimize your databases.

Salesforce DML and Database Operations: The Ultimate Guide

DML statements are simple and efficient for small, reliable datasets. However, for scalable, bulk-safe, and error-tolerant operations, the Database class is the gold standard.



XENTRY Frame

Version with no cookie popup
Version with Usercentrics v1
Version with Usercentrics v2
Version with cross domain and MFA redirect
Version with Session expired to show Dialog
These links are used in



Data Manipulation Language(DML) in Salesforce Apex :

Additionally, I will explain the operations that can be performed in DML and how to execute DML operations within Apex classes. What is DML in



Automotive after sales management solution from DealerBox

Take your service management to a whole new level DealerBox gives you a complete overview of your dealership's aftersales cycle - from



Automotive after sales management solution from DealerBox

After-sales Precise service maintenance for your clients Industries Take your service management to a whole new level DealerBox gives you



Contact Us

For datasheets, pricing, or custom high-speed optical interconnect solutions, please visit:
<https://www.syropy.com.pl>